

User Manual

Revision 1.000

English

DMX / RS485 - Converter

(Order Code: HD67046-B2)

For Website information:

www.adfweb.com?Product=HD67046

For Price information:

www.adfweb.com?Price=HD67046-B2

Benefits and Main Features:

- ⊕ Very easy to configure
- ⊕ Triple electrical isolation
- ⊕ Temperature range: -40°C/85°C (-40°F/185°F)



For others DMX products see also the following link:

Converter DMX to

- www.adfweb.com?Product=HD67039
- www.adfweb.com?Product=HD67040
- www.adfweb.com?Product=HD67041
- www.adfweb.com?Product=HD67509
- www.adfweb.com?Product=HD67517
- www.adfweb.com?Product=HD67518
- www.adfweb.com?Product=HD67519
- www.adfweb.com?Product=HD67588
- www.adfweb.com?Product=HD67614
- www.adfweb.com?Product=HD67670
- www.adfweb.com?Product=HD67704
- www.adfweb.com?Product=HD67821
- www.adfweb.com?Product=HD67838
- www.adfweb.com?Product=HD67944
- www.adfweb.com?Product=HD67B15
- www.adfweb.com?Product=HD67B37
- www.adfweb.com?Product=HD67D23
- www.adfweb.com?Product=HD67E11

- (Ethernet)
- (SNMP Agent)
- (SNMP Manager)
- (Modbus TCP Slave)
- (Modbus Slave)
- (Modbus Master)
- (Modbus TCP Master)
- (EtherNet/IP Slave)
- (PROFINET Slave)
- (BACnet Slave)
- (BACnet Master)
- (KNX)
- (DALI)
- (MQTT)
- (OPC UA Client)
- (OPC UA Server)
- (LoRaWAN)
- (EtherCAT Slave)

Do you have an your customer protocol?

www.adfweb.com?Product=HD67003

Do you need to choose a device? do you want help?

www.adfweb.com?Cmd=helpme



User Manual

**INDEX:**

	Page
INDEX	2
UPDATED DOCUMENTATION	2
REVISION LIST	2
WARNING	2
TRADEMARKS	2
SECURITY ALERT	3
EXAMPLE OF CONNECTION	4
CONNECTION SCHEME	5
CHARACTERISTICS	6
CONFIGURATION	6
POWER SUPPLY	7
FUNCTION MODES	8
LEDS	9
RS485	10
RS485 (DMX)	11
ETHERNET	12
USE OF COMPOSITOR SW67046	13
NEW CONFIGURATION / OPEN CONFIGURATION	14
SOFTWARE OPTIONS	15
SET COMMUNICATION	17
DMX DEFAULT VALUE	18
UPDATE DEVICE	19
SERIAL PROTOCOL	21
MECHANICAL DIMENSIONS	23
ORDERING INFORMATIONS	24
ACCESSORIES	24
DISCLAIMER	25
OTHER REGULATIONS AND STANDARDS	25
WARRANTIES AND TECHNICAL SUPPORT	26
RETURN POLICY	26

UPDATED DOCUMENTATION:

Dear customer, we thank you for your attention and we remind you that you need to check that the following document is:

- Updated
- Related to the product you own

To obtain the most recently updated document, note the "document code" that appears at the top right-hand corner of each page of this document.

With this "Document Code" go to web page www.adfweb.com/download/ and search for the corresponding code on the page. Click on the proper "Document Code" and download the updates.

REVISION LIST:

Revision	Date	Author	Chapter	Description
1.000	12/10/2020	Ff	All	First Release

WARNING:

ADFweb.com reserves the right to change information in this manual about our product without warning.
ADFweb.com is not responsible for any error this manual may contain.

TRADEMARKS:

All trademarks mentioned in this document belong to their respective owners.

SECURITY ALERT:**GENERAL INFORMATION**

To ensure safe operation, the device must be operated according to the instructions in the manual. When using the device, legal and safety regulation are required for each individual application. The same applies also when using accessories.

INTENDED USE

Machines and systems must be designed so the faulty conditions do not lead to a dangerous situation for the operator (i.e. independent limit switches, mechanical interlocks, etc.).

QUALIFIED PERSONNEL

The device can be used only by qualified personnel, strictly in accordance with the specifications.

Qualified personnel are persons who are familiar with the installation, assembly, commissioning and operation of this equipment and who have appropriate qualifications for their job.

RESIDUAL RISKS

The device is state-of-the-art and is safe. The instruments can represent a potential hazard if they are inappropriately installed and operated by untrained personnel. These instructions refer to residual risks with the following symbol:



This symbol indicates that non-observance of the safety instructions is a danger for people that could lead to serious injury or death and / or the possibility of damage.

CE CONFORMITY

The declaration is made by our company. You can send an email to support@adfweb.com or give us a call if you need it.

EXAMPLE OF CONNECTION:

DMX / Serial - Converter
HD67046-B2

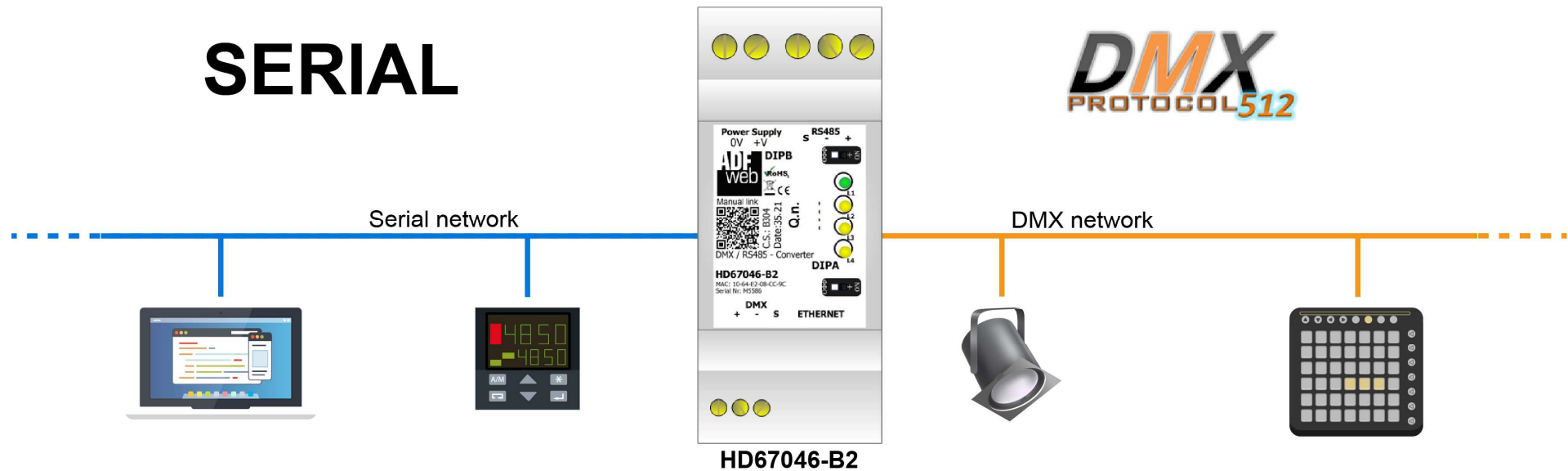

ADFweb.com



+39 0438 309 131



+39 349 440 9592



support@adfweb.com

CONNECTION SCHEME:

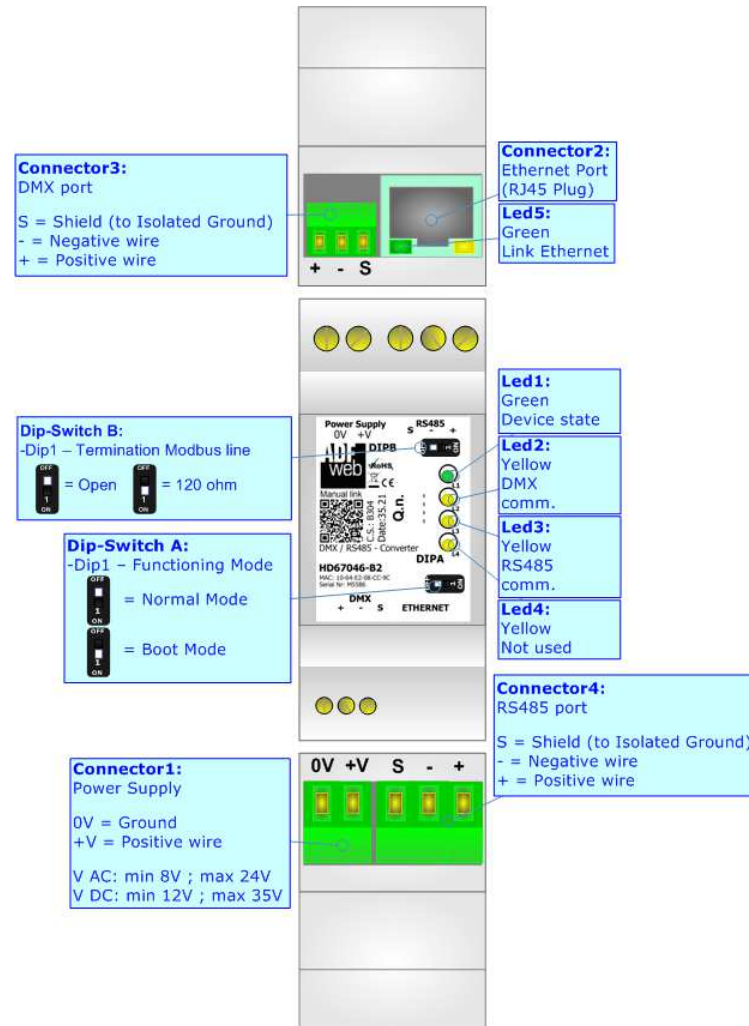

Figure 1: Connection scheme for HD67046-B2

CHARACTERISTICS:

The HD67046-B2 is a converter from RS485 to DMX and vice versa.

They allow the following characteristics:

- Triple isolation between RS485 - Power Supply, RS485 - DMX, Power Supply - DMX.
- Two-directional information between RS485 bus and DMX bus;
- Mountable on 35mm Rail DIN;
- Wide power supply input range: 8...24V AC or 12...35V DC;
- Wide temperature range: -40°C / 85°C [-40°F / +185°F].



CONFIGURATION:

You need Compositor SW67046 software on your PC in order to perform the following:

- Define the parameter of RS485 line;
- Define the parameter of DMX line;
- Update the device.

POWER SUPPLY:

The devices can be powered at 8...24V AC and 12...35V DC. For more details see the two tables below.

VAC 		VDC 	
Vmin	Vmax	Vmin	Vmax
8V	24V	12V	35V

Consumption at 24V DC:

Device	Consumption [W/VA]
HD67046-B2	3.5

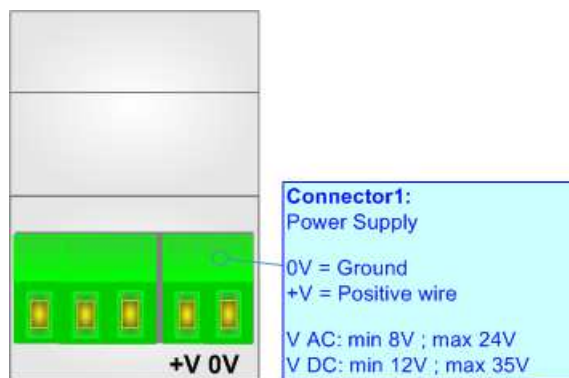

Caution: Not reverse the polarity power

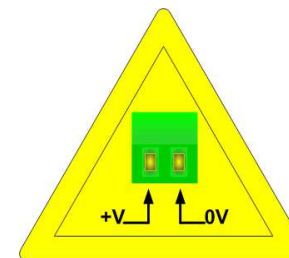

HD67046-B2

FUNCTION MODES:

The device has got two functions mode depending of the position of the 'Dip1 of Dip-Switch A':

- The first, with 'Dip1 of Dip-Switch A' at "OFF" position, is used for the normal working of the device.
- The second, with 'Dip1 of Dip-Switch A' at "ON" position, is used for upload the Project and/or Firmware.

For the operations to follow for the updating, see 'UPDATE DEVICE' section.

According to the functioning mode, the LEDs will have specifics functions, see 'LEDS' section.

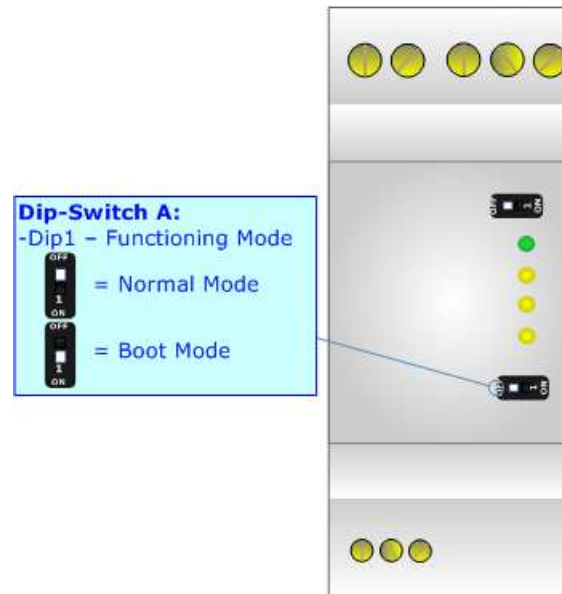

LEDS:

The device has got five LEDs that are used to give information of the functioning status.
The various meanings of the LEDs are described in the table below.

LED	Normal Mode	Boot Mode
1: Device State (green)	Blinks slowly (~1Hz)	ON: Device powered OFF: Device not powered
2: RS485 communication (yellow)	Blinks when a RS485 request is received	Blinks quickly: Boot state Blinks very slowly (~0.5Hz): update in progress
3: DMX communication (yellow)	Blinks when a DMX frame is received	Blinks quickly: Boot state Blinks very slowly (~0.5Hz): update in progress
4: Not used (yellow)	OFF	Blinks quickly: Boot state Blinks very slowly (~0.5Hz): update in progress
5: Ethernet Link (green)	ON: Ethernet cable connected OFF: Ethernet cable disconnected	ON: Ethernet cable connected OFF: Ethernet cable disconnected

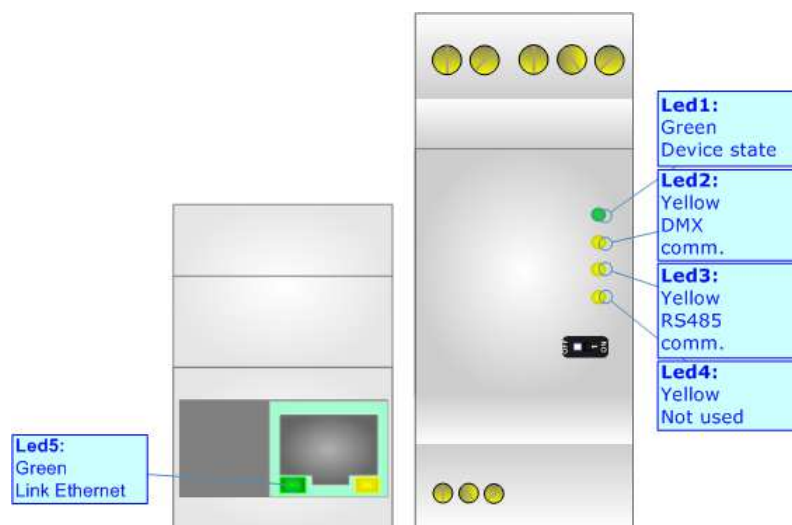

RS485:

For terminate the RS485 line with a 120Ω resistor it is necessary to put ON dip 1, like in figure.

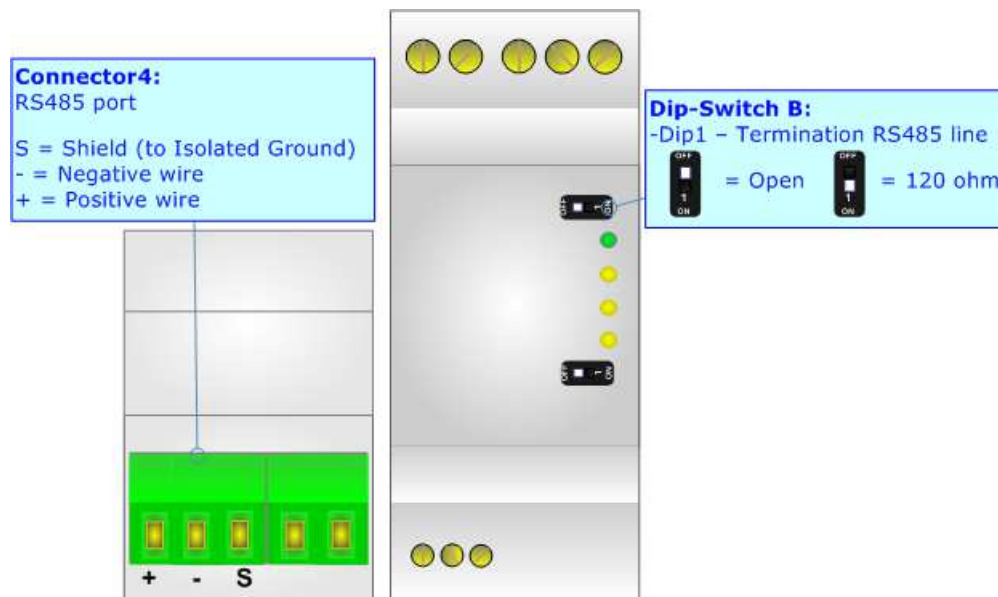

The maximum length of the cable should be 1200m (4000 feet).

Here some codes of cables:

- Belden: p/n 8132 - 2x 28AWG stranded twisted pairs conductor + foil shield + braid shield;
- Belden p/n 82842 - 2x 24AWG stranded twisted pairs conductor + foil shield + braid shield;
- Tasker: p/n C521 - 1x 24AWG twisted pair conductor + foil shield + braid shield;
- Tasker: p/n C522 - 2x 24AWG twisted pairs conductor + foil shield + braid shield.

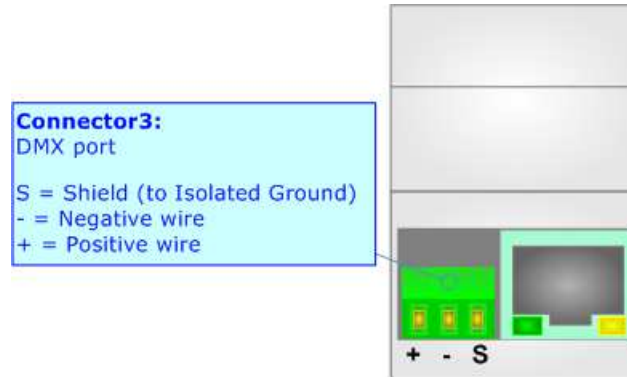
RS485 (DMX):

The maximum length of the cable should be 1200m (4000 feet).

Here some codes of cables:

- Belden: p/n 8132 - 2x 28AWG stranded twisted pairs conductor + foil shield + braid shield;
- Belden p/n 82842 - 2x 24AWG stranded twisted pairs conductor + foil shield + braid shield;
- Tasker: p/n C521 - 1x 24AWG twisted pair conductor + foil shield + braid shield;
- Tasker: p/n C522 - 2x 24AWG twisted pairs conductor + foil shield + braid shield.

ETHERNET:

The Ethernet port is used for programming the device.

The Ethernet connection must be made using Connector2 of HD67046-B2 with at least a Category 5E cable. The maximum length of the cable should not exceed 100m. The cable has to conform to the T568 norms relative to connections in cat.5 up to 100 Mbps. To connect the device to an Hub/Switch is recommended the use of a straight cable, to connect the device to a PC is recommended the use of a cross cable.

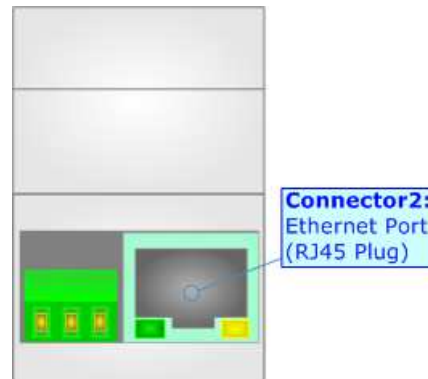

USE OF COMPOSITOR SW67046:

To configure the Converter, use the available software that runs with Windows called SW67046. It is downloadable from the site www.adfweb.com and its operation is described in this document (*this manual is referenced to the last version of the software present on our web site*). The software works with MSWindows (XP, Vista, Seven, 8, 10; 32/64bit).

When launching the SW67046, the window below appears (Fig. 2).

**Note:**

It is necessary to have installed .Net Framework 4.

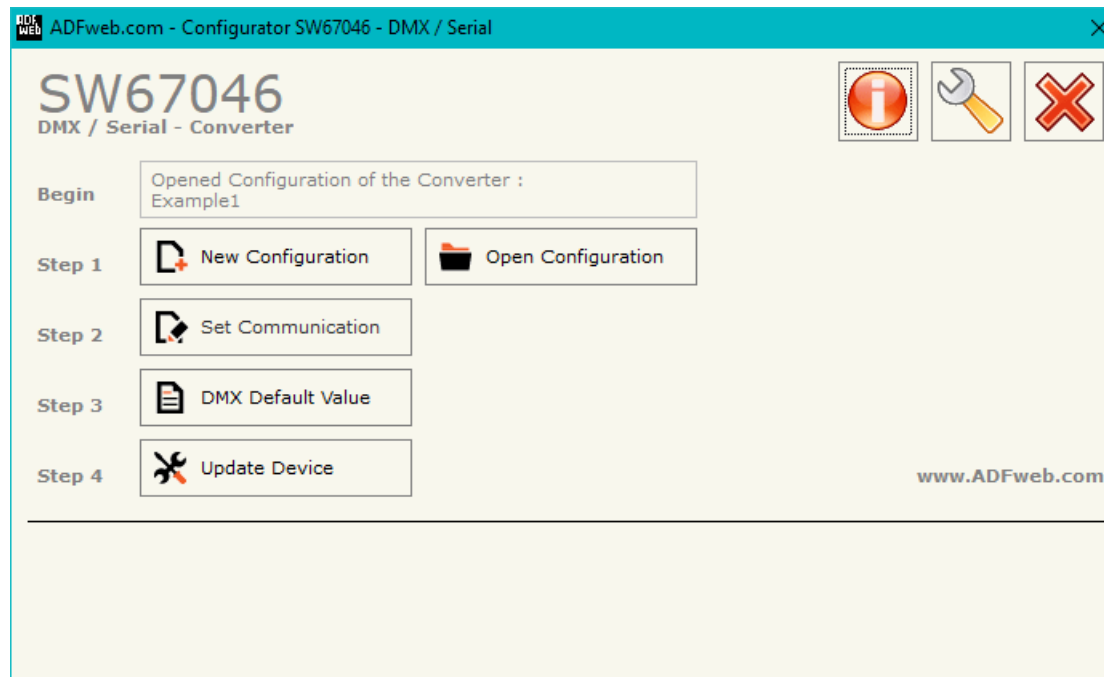
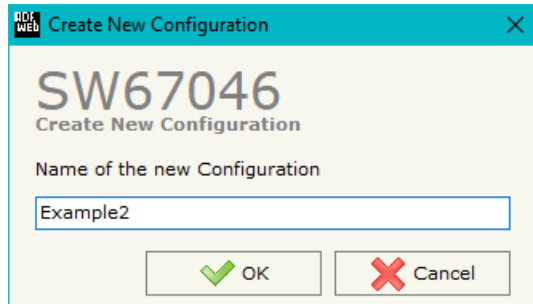

Figure 2: Main window for SW67046

NEW CONFIGURATION / OPEN CONFIGURATION:

The “**New Configuration**” button creates the folder which contains the entire device’s configuration.



A device’s configuration can also be imported or exported:

- To clone the configurations of a Programmable “DMX / RS485 - Converter” in order to configure another device in the same manner, it is necessary to maintain the folder and all its contents;
- To clone a project in order to obtain a different version of the project, it is sufficient to duplicate the project folder with another name and open the new folder with the button “**Open Configuration**”.

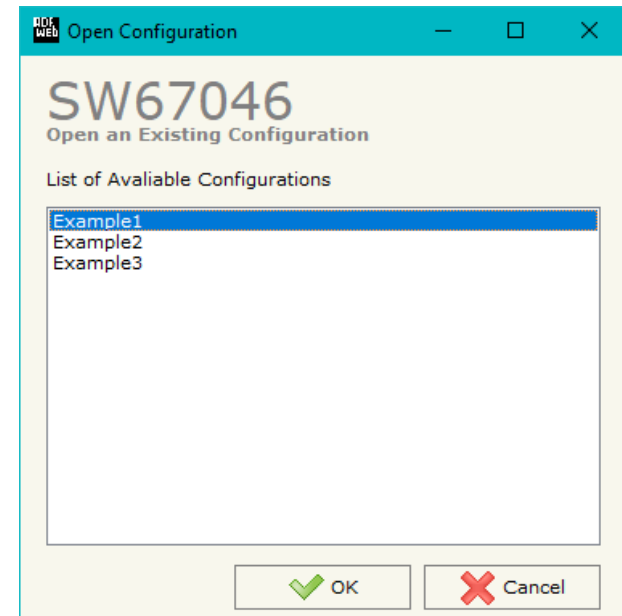

SOFTWARE OPTIONS:

By pressing the “**Settings**” () button there is the possibility to change the language of the software and check the updatings for the compositor.

In the section “Language” it is possible to change the language of the software.

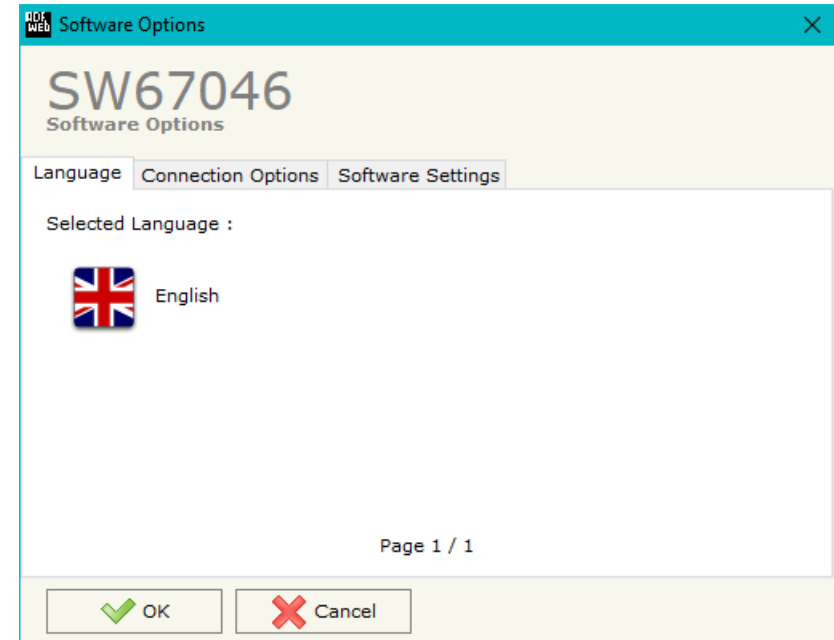
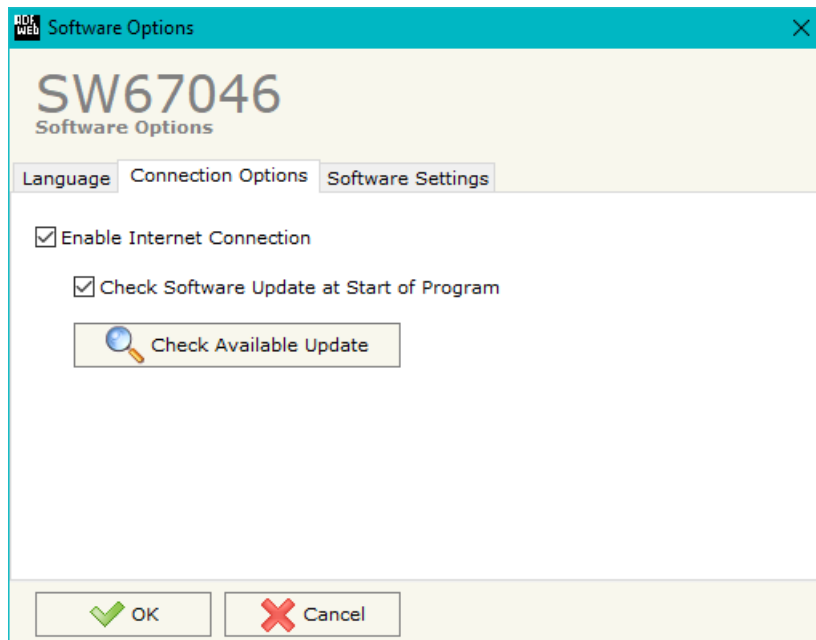

In the section “Connection Options”, it is possible to check if there are some updatings of the software compositor in ADFweb.com website. Checking the option “**Check Software Update at Start of Program**”, the SW67046 check automatically if there are updatings when it is launched.

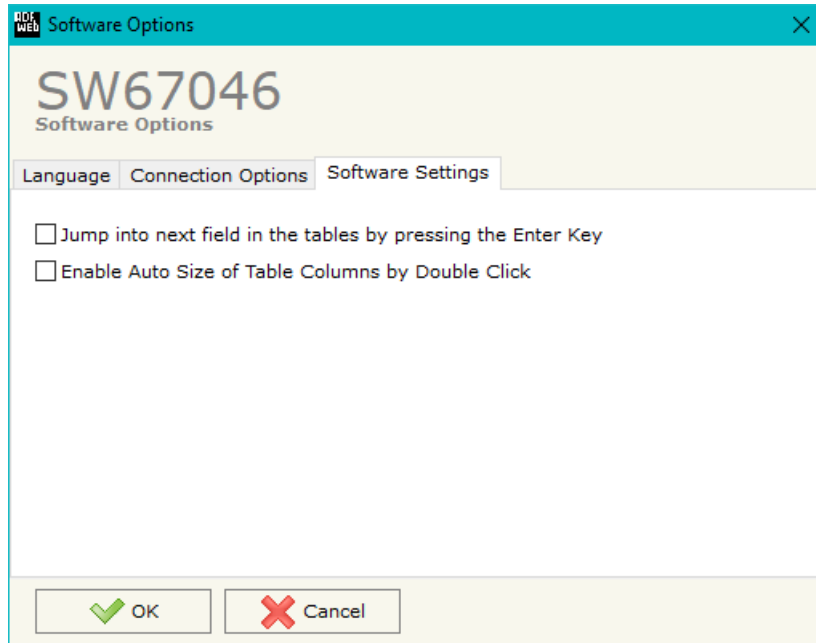

In the section "Software Settings", it is possible to enable/disable some keyboard's commands for an easier navigation inside the tables contained in the different sections of the software.

SET COMMUNICATION:

This section define the main communication parameters of two buses, RS485 and DMX.

By Pressing the **"Set Communication"** button from the main window for SW67046 (Fig. 2) the window "Set Communication" appears (Fig. 3).

The means of the fields for "DMX" section are:

- In the field **"DMX"** it is possible to define if the converter will act as DMX controller ("OUT") or as DMX device ("IN");
- In the field **"Channel Number"** the number of channels of the DMX side is defined (up to 512 channels);
- If the field **"Enable End-Line Resistor"** is checked, the termination resistor for DMX line is inserted.

The means of the fields for "RS485" are:

- In the field **"Serial"** the serial port to use is defined;
- In the field **"Baudrate"** the baudrate for the serial line is defined;
- In the field **"Parity"** the parity of the serial line is defined;
- In the field **"Stop Bits"** the number of Stop Bits of the serial line is defined.

The means of the fields for "Ethernet" are:

- In the field **"IP ADDRESS"** the IP address of the converter is defined;
- In the field **"SUBNET Mask"** the SubNet Mask of the converter is defined;
- In the field **"GATEWAY"** the default gateway of the network is defined. This feature can be enabled or disabled pressing the Check Box field. This feature is used for going out of the net.

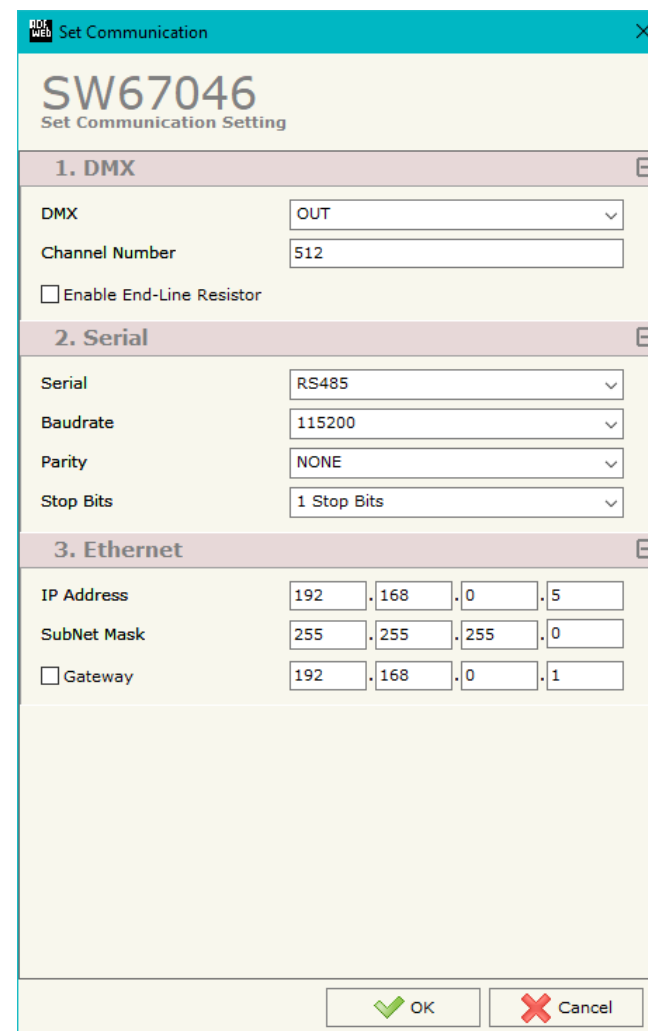

Figure 3: "Set Communication" window

DMX DEFAULT VALUE:

By pressing the “**DMX Default Value**” button from the main window for SW67046 (Fig. 2) the “DMX Default Value” window appears (Fig. 4). In this section it is possible to define the default value for each channel of the DMX array when the converter is turned ON.

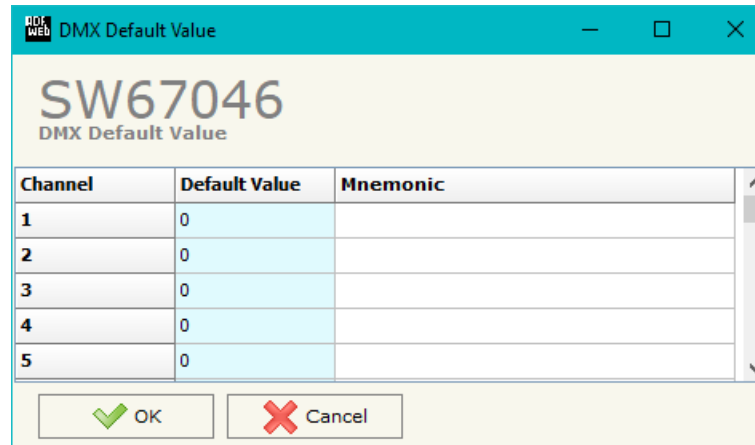

Figure 4: “DMX Default Value” window

UPDATE DEVICE:

By pressing the **“Update Device”** button, it is possible to load the created Configuration into the device; and also the Firmware, if necessary. This by using the Ethernet port.

If you don't know the actual IP address of the device you have to use this procedure:

- Turn OFF the Device;
- Put Dip1 of 'Dip-Switch A' in ON position;
- Turn ON the device
- Connect the Ethernet cable;
- Insert the IP **“192.168.2.205”**;
- Select which operations you want to do;
- Press the **“Execute update firmware”** button to start the upload;
- When all the operations are “OK” turn OFF the Device;
- Put Dip1 of 'Dip-Switch A' in OFF position;
- Turn ON the device.

If you know the actual IP address of the device, you have to use this procedure:

- Turn ON the Device with the Ethernet cable inserted;
- Insert the actual IP of the Converter;
- Select which operations you want to do;
- Press the **“Execute update firmware”** button to start the upload;
- When all the operations are “OK” the device automatically goes at Normal Mode.

At this point the configuration/firmware on the device is correctly updated.

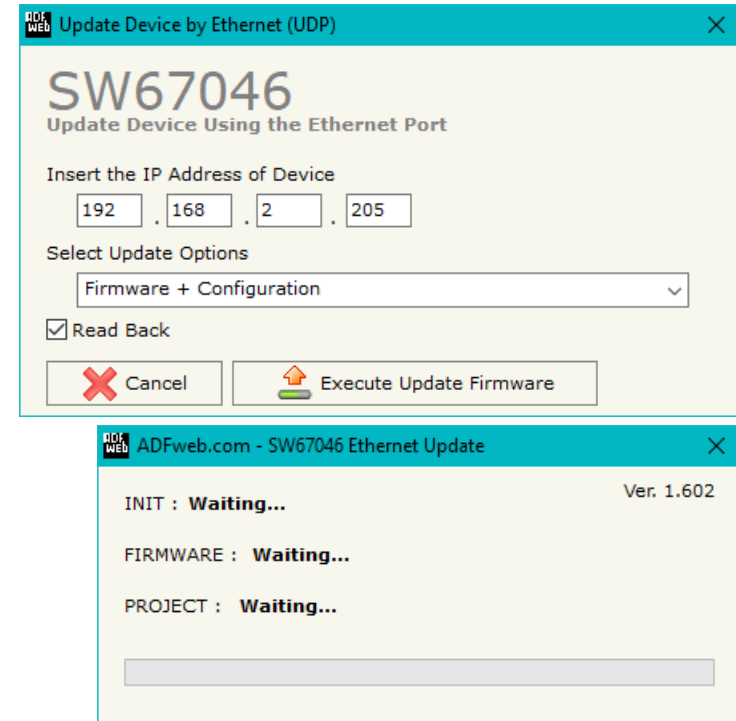





Figure 5: “Update device” windows

 **Note:**
When you install a new version of the software, if it is the first time it is better you do the update of the Firmware in the HD67046 device.

 **Note:**
When you receive the device, for the first time, you also have to update the Firmware in the HD67046 device.

 **Warning:**
If Fig. 6 appears when you try to do the Update try these points before seeking assistance:

- Try to repeat the operations for the updating;
- Try with another PC;
- Try to restart the PC;
- Check the LAN settings;
- Check the Wi-Fi settings;
- If you are using the program inside a Virtual Machine, try to use in the main Operating System;
- If you are using Windows Seven, Vista, 8 or 10 make sure that you have the administrator privileges;
- In case you have to program more than one device, using the "UDP Update", you have to cancel the ARP table every time you connect a new device on Ethernet. For do this you have to launch the "Command Prompt" and write the command "arp -d". Pay attention that with Windows Vista, Seven, 8, 10 you have to launch the "Command Prompt" with Administrator Rights;
- Pay attention at Firewall lock.

 In the case of HD67046 you have to use the software "SW67046": www.adfweb.com/download/filefold/SW67046.zip.

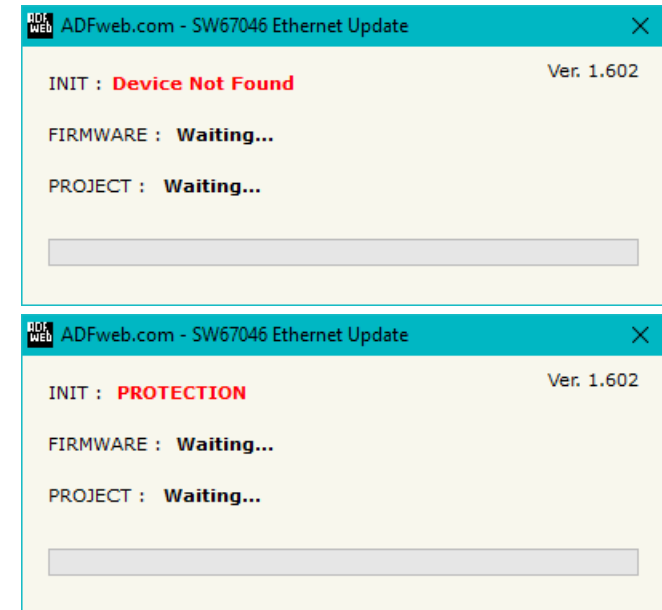

Figure 6: "Protection" window

SERIAL PROTOCOL

DMX WRITE (WHEN DMX = DMX OUT)

The bytes that compose the request are these:

Byte Number	Description
1	ASCII char 'D'
2	ASCII char 'M'
3	ASCII char 'X'
4	ASCII char 'W'
5	ASCII char '.'
6 ÷ 8	0 ÷ 511 → Starting DMX channel in ASCII format
9	ASCII char '.'
10 ÷ 12	1 ÷ 512 → Number of consecutive DMX channels in ASCII format
13	ASCII char '.'
11 ÷ n+11	Value in Hex for each DMX channels

n = Number of DMX channels

If the request is correct, the bytes that compose the response are these:

Byte Number	Description
1	ASCII char 'D'
2	ASCII char ':'
3 ÷ n+3	Value in Hex for each DMX channels

DMX READ (WHEN DMX = DMX IN)

The bytes that compose the request are these:

Byte Number	Description
1	ASCII char 'D'
2	ASCII char 'M'
3	ASCII char 'X'
4	ASCII char 'R'
5	ASCII char '.'
6 ÷ 8	0 ÷ 511 → Starting DMX channel in ASCII format
9	ASCII char '.'
10 ÷ 12	1 ÷ 512 → Number of consecutive DMX channels in ASCII format

If the request is correct, the bytes that compose the response are these:

Byte Number	Description
1	ASCII char 'D'
2	ASCII char ':'
3 ÷ n+3	Value in Hex for each DMX channels

MECHANICAL DIMENSIONS:

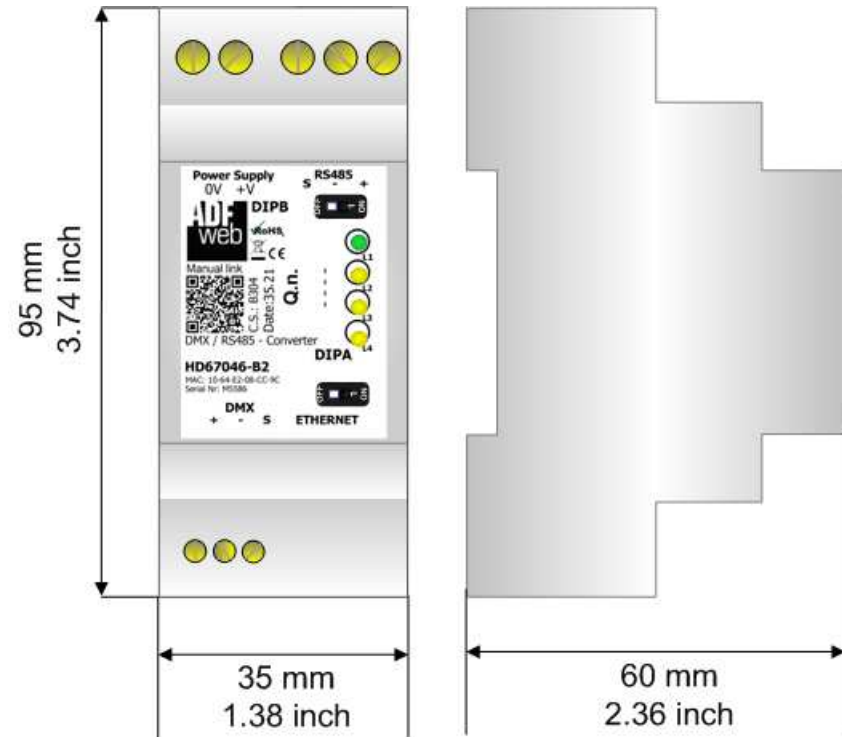

Housing: PVC
 Weight: 200g
 (Approx)

Figure 7: Mechanical dimensions scheme for HD67046-B2

ORDERING INFORMATIONS:

The ordering part number is formed by a valid combination of the following:

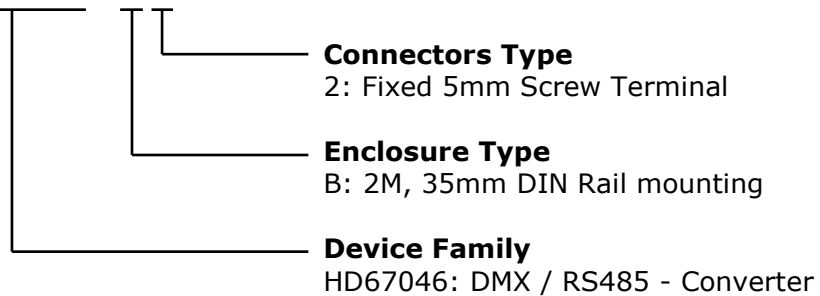
HD67046 - B 2

Order Code: **HD67046-B2** - DMX / RS485 - Converter

ACCESSORIES:

Order Code: **AC34011** - Rail DIN - Power Supply 220/240V AC 50/60Hz - 12 V DC

Order Code: **AC34012** - Rail DIN - Power Supply 220/240V AC 50/60Hz - 24 V DC

DISCLAIMER:

All technical content within this document can be modified without notice. The content of the document is a under continual renewal. For losses due to fire, earthquake, third party access or other accidents, or intentional or accidental abuse, misuse, or use under abnormal conditions repairs are charged to the user. ADFweb.com S.r.l. will not be liable for accidental loss of use or inability to use this product, such as loss of business income. ADFweb.com S.r.l. shall not be liable for consequences of improper use.

OTHER REGULATIONS AND STANDARDS:**WEEE INFORMATION**

Disposal of old electrical and electronic equipment (as in the European Union and other European countries with separate collection systems).

— This symbol on the product or on its packaging indicates that this product may not be treated as household rubbish. Instead, it should be taken to an applicable collection point for the recycling of electrical and electronic equipment. If the product is disposed correctly, you will help prevent potential negative environmental factors and impact of human health, which could otherwise be caused by inappropriate disposal. The recycling of materials will help to conserve natural resources. For more information about recycling this product, please contact your local city office, your household waste disposal service or the shop where you purchased the product.

RESTRICTION OF HAZARDOUS SUBSTANCES DIRECTIVE

The device respects the 2002/95/EC Directive on the restriction of the use of certain hazardous substances in electrical and electronic equipment (commonly referred to as Restriction of Hazardous Substances Directive or RoHS).

CE MARKING

The product conforms with the essential requirements of the applicable EC directives.

WARRANTIES AND TECHNICAL SUPPORT:

For fast and easy technical support for your ADFweb.com SRL products, consult our internet support at www.adfweb.com. Otherwise contact us at the address support@adfweb.com

RETURN POLICY:

If while using your product you have any problem and you wish to exchange or repair it, please do the following:

- Obtain a Product Return Number (PRN) from our internet support at www.adfweb.com. Together with the request, you need to provide detailed information about the problem.
- Send the product to the address provided with the PRN, having prepaid the shipping costs (shipment costs billed to us will not be accepted).

If the product is within the warranty of twelve months, it will be repaired or exchanged and returned within three weeks. If the product is no longer under warranty, you will receive a repair estimate.



ADFweb.com S.r.l.
Via Strada Nuova, 17
IT-31010 Mareno di Piave
TREVISO (Italy)
Phone +39.0438.30.91.31
Fax +39.0438.49.20.99
www.adfweb.com

