

User Manual

Revision 1.300

English

M-Bus Master/ BACnet Slave - Converter

(Order Codes: HD67056-B2-20, HD67056-B2-40,
HD67056-B2-80, HD67056-B2-160,
HD67056-B2-250)

(Order Codes: HD67056-MSTP-20, HD67056-MSTP-40,
HD67056- MSTP-80, HD67056-MSTP-160,
HD67056- MSTP-250)

For Website information:

www.adfweb.com?Product=HD67056-B2

For Price information:

www.adfweb.com?Price=HD67056-B2-20

www.adfweb.com?Price=HD67056-B2-40

www.adfweb.com?Price=HD67056-B2-80

www.adfweb.com?Price=HD67056-B2-160

www.adfweb.com?Price=HD67056-B2-250

Benefits and Main Features:

- ⊕ Very easy to configure
- ⊕ Up to 250 standard M-Bus devices connected to the Converter
- ⊕ Power Supply 15...21V AC or 18...35V DC
- ⊕ Temperature range: -40°C/+85°C (-40°F/+185°F)



For others M-Bus products see also the following link:

Converter - M-Bus /

www.adfweb.com?Product=HD67021 **(RS232)**

www.adfweb.com?Product=HD67022 **(RS485)**

Analyzer / Scanner / Sniffer M-Bus

www.adfweb.com?Product=HD67031

M-Bus – Repeater - Isolator

www.adfweb.com?Product=HD67032M

Converter - M-Bus / Modbus Slave

www.adfweb.com?Product=HD67029M-232 **(on RS232)**

www.adfweb.com?Product=HD67029M-485 **(on RS485)**

Gateway M-Bus / Modbus TCP

www.adfweb.com?Product=HD67044

Gateway M-Bus / CANopen

www.adfweb.com?Product=HD67051-B2

Gateway M-Bus / PROFIBUS

www.adfweb.com?Product=HD67053M

Gateway M-Bus Concentrator

www.adfweb.com?Product=HD67054M

Gateway M-Bus Slave / Modbus RTU master

www.adfweb.com?Product=HD67059M-232

Do you have an your customer protocol?

www.adfweb.com?Product=HD67003

Do you need to choose a device? do you want help?

www.adfweb.com?Cmd=helpme



User Manual

INDEX:

	Page
INDEX	2
UPDATED DOCUMENTATION	2
REVISION LIST	2
WARNING	2
TRADEMARKS	2
SECURITY ALERT	3
EXAMPLE OF CONNECTION	4
CONNECTION SCHEME	5
CHARACTERISTICS	7
CONFIGURATION	7
POWER SUPPLY	8
FUNCTION MODES	9
LEDS	10
BACNET/IP (HD67056-B2-XXX SERIE)	11
BACNET MS/TP (HD67056-MSTP-XXX SERIE)	11
M-BUS	12
USE OF COMPOSITOR SW67056	13
NEW PROJECT / OPEN PROJECT	14
SOFTWARE OPTIONS	15
SET COMMUNICATION	17
M-BUS	19
BACNET EDE FILE	30
UPDATE DEVICE	32
SCAN & DECODE FUNCTION	34
MECHANICAL DIMENSIONS	35
ORDERING INFORMATIONS	36
ACCESSORIES	37
DISCLAIMER	38
OTHER REGULATIONS AND STANDARDS	38
WARRANTIES AND TECHNICAL SUPPORT	39
RETURN POLICY	39

UPDATED DOCUMENTATION:

Dear customer, we thank you for your attention and we remind you that you need to check that the following document is:

- ✦ Updated
- ✦ Related to the product you own

To obtain the most recently updated document, note the “Document code” that appears at the top right-hand corner of each page of this document.

With this “Document Code” go to web page www.adfweb.com/download/ and search for the corresponding code on the page. Click on the proper “Document Code” and download the updates.

REVISION LIST:

Revision	Date	Author	Chapter	Description
1.110	14/10/2013	Fl	All	Software changed (v1.102)
1.120	27/02/2014	Fl	All	Software changed (v1.104)
1.130	27/05/2014	Fl	All	Software changed (v1.200)
1.200	15/06/2017	Ff	All	New hardware version
1.300	14/04/2023	Ln	All	New hardware version

WARNING:

ADFweb.com reserves the right to change information in this manual about our product without warning. ADFweb.com is not responsible for any error this manual may contain.

TRADEMARKS:

All trademarks mentioned in this document belong to their respective owners.

SECURITY ALERT:**GENERAL INFORMATION**

To ensure safe operation, the device must be operated according to the instructions in the manual. When using the device, legal and safety regulation are required for each individual application. The same applies also when using accessories.

INTENDED USE

Machines and systems must be designed so the faulty conditions do not lead to a dangerous situation for the operator (i.e. independent limit switches, mechanical interlocks, etc.).

QUALIFIED PERSONNEL

The device can be used only by qualified personnel, strictly in accordance with the specifications. Qualified personnel are persons who are familiar with the installation, assembly, commissioning and operation of this equipment and who have appropriate qualifications for their job.

RESIDUAL RISKS

The device is state-of-the-art and is safe. The instruments can represent a potential hazard if they are inappropriately installed and operated by untrained personnel. These instructions refer to residual risks with the following symbol:



This symbol indicates that non-observance of the safety instructions is a danger for people that could lead to serious injury or death and / or the possibility of damage.

CE CONFORMITY

The declaration is made by our company. You can send an email to support@adfweb.com or give us a call if you need it.

EXAMPLE OF CONNECTION:

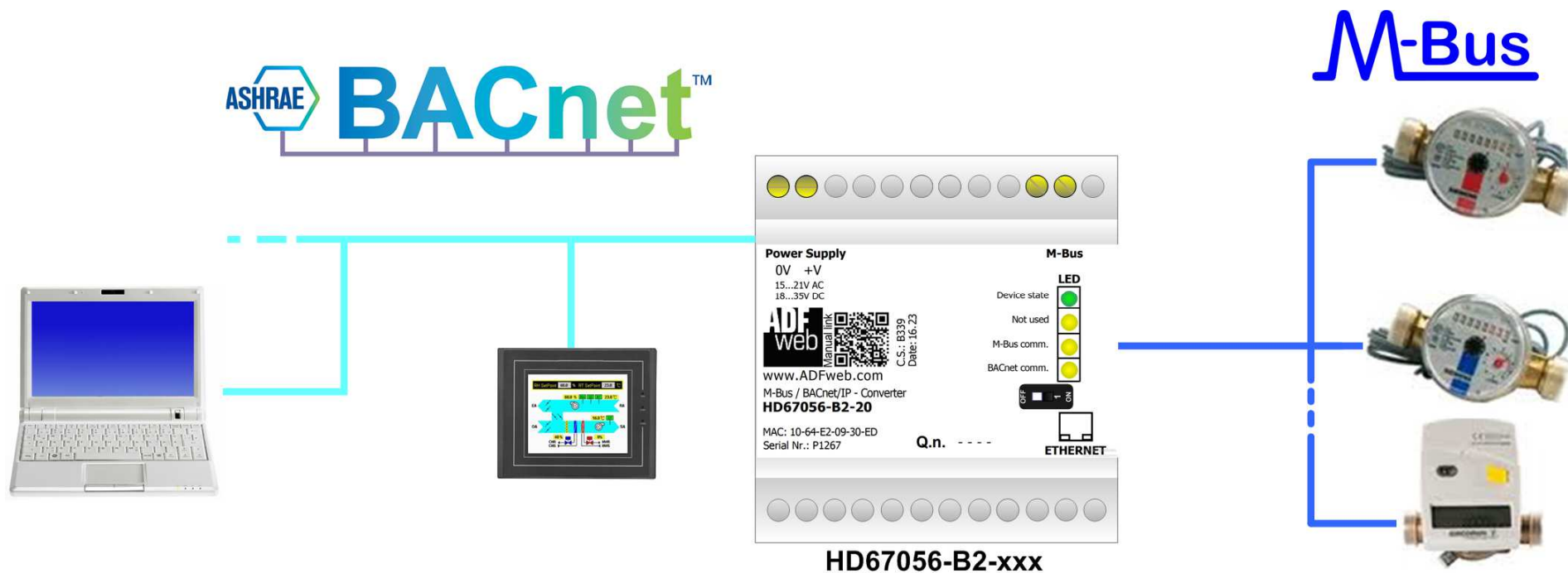

CONNECTION SCHEME:

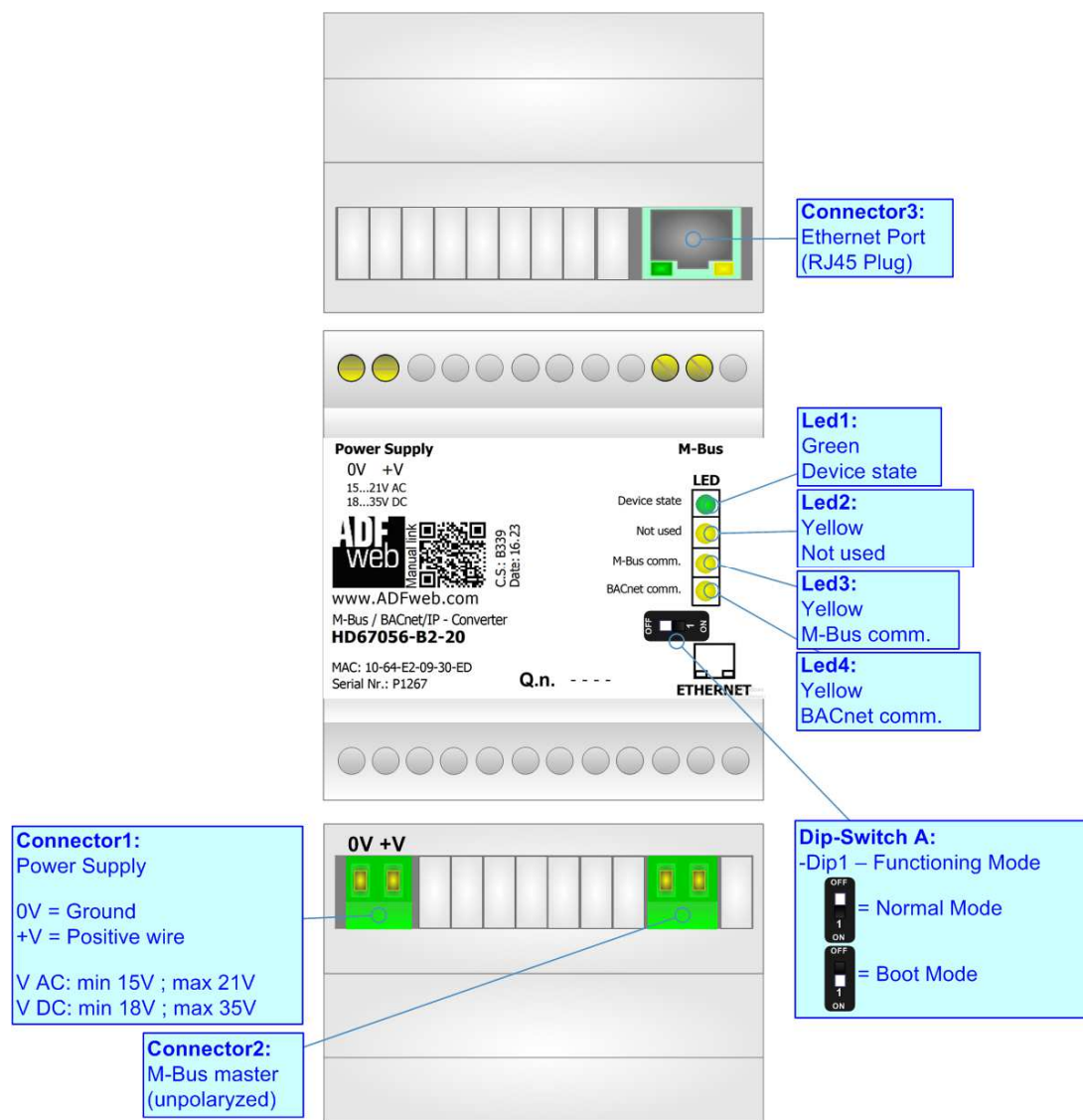

Figure 1a: Connection scheme for HD67056-B2-xxx

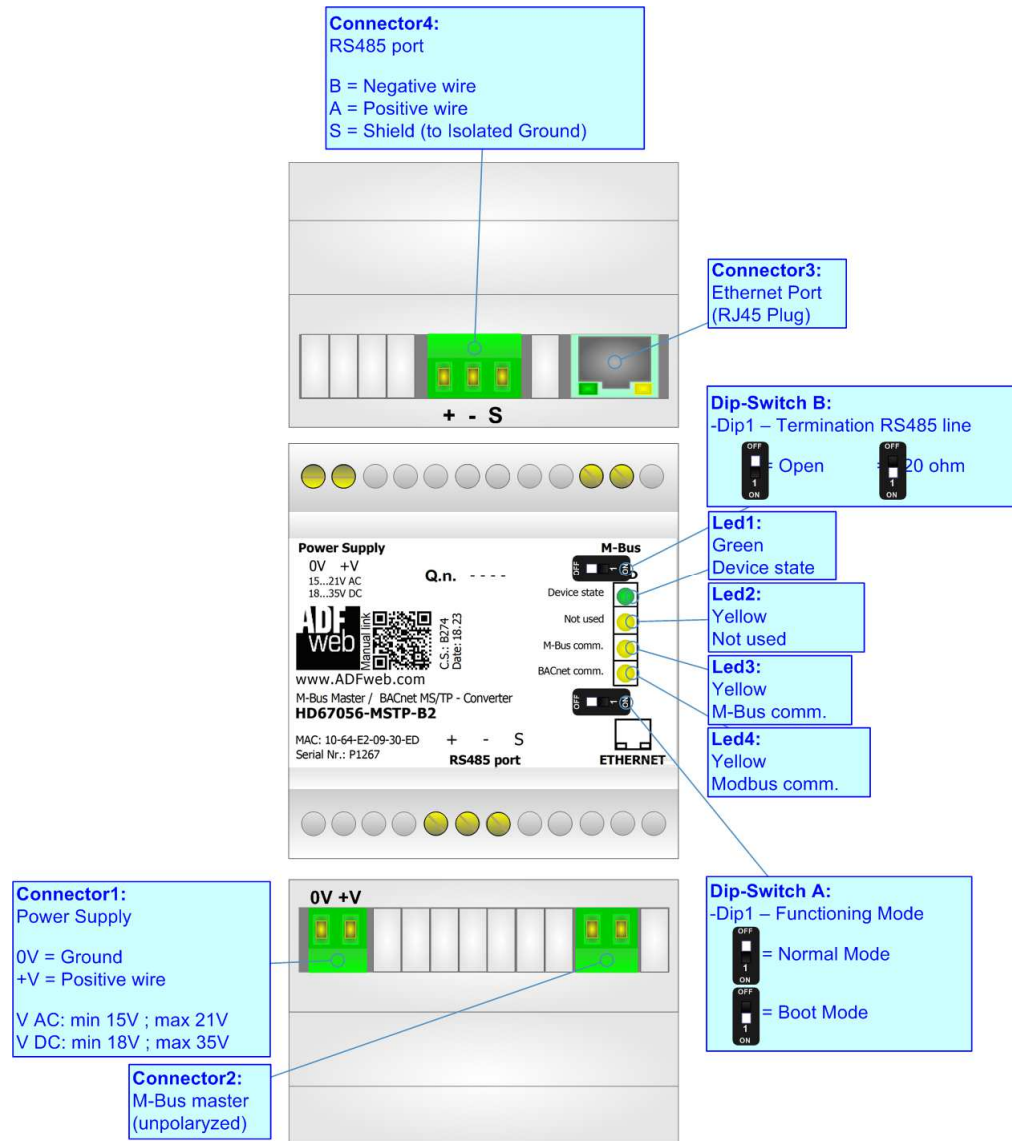

Figure 1b: Connection scheme for HD67056-MSTP-xxx

CHARACTERISTICS:

The HD67056 is a M-Bus Master / BACnet Converter.

It allows the following characteristics:

- Electrical isolation between Ethernet and M-Bus (for HD67056-B2-xxx serie);
- Electrical isolation between RS485 and M-Bus (for HD67056-MSTP-xxx serie);
- Mountable on 35mm Rail DIN;
- Power Supply 15...21V AC or 18...35V DC;
- Temperature range -40°C to 85°C.

At the Converter can be connected up to 250 standard M-Bus devices. This number depends of the code expressed by the xxx number:

- HD67056-B2-20 and HD67056-MSTP-20 support up to 20 M-Bus devices;
- HD67056-B2-40 and HD67056-MSTP-40 support up to 40 M-Bus devices;
- HD67056-B2-80 and HD67056-MSTP-80 support up to 80 M-Bus devices;
- HD67056-B2-160 and HD67056-MSTP-160 support up to 160 M-Bus devices;
- HD67056-B2-250 and HD67056-MSTP-250 support up to 250 M-Bus devices.

 In the case of HD67056-xxx-160 the device must be mounted on 35mm DIN rail which is horizontally mounted on a wall or cabinet back-plate. To avoid obstructions to the airflow around the unit it is recommended to not cover the paths of air.

 In the case of HD67056-xxx-250 the device must be mounted on 35mm DIN rail which is horizontally mounted on a wall or cabinet back-plate. These units have a fan in the top of the enclosure. To avoid obstructions to the airflow around the unit it is recommended to not cover the paths of air. Take care to not cover the fan. It is recommended to put the device into a ventilated cabinet.

CONFIGURATION:

You need Compositor SW67056 software on your PC in order to perform the following:

- Define the parameter of BACnet line;
- Define the parameter of M-Bus line;
- Define which M-Bus variables are readable on BACnet ;
- Update the device.

POWER SUPPLY:

The devices can be powered at 15...21V AC and 18...35V DC. The consumption depends to the code of the device. For more details see the two tables below.

VAC		VDC	
Vmin	Vmax	Vmin	Vmax
15V	21V	18V	35V

Consumption at 24V DC:

Device	No Load [W/VA]	Full Load [W/VA]*
HD67056-B2-20, HD67056-MSTP-20	3.5	4
HD67056-B2-40, HD67056-MSTP-40		5
HD67056-B2-80, HD67056-MSTP-80		8
HD67056-B2-160, HD67056-MSTP-160		14
HD67056-B2-250, HD67056-MSTP-250		30

* This value is with all the Slave M-Bus devices of the code (20, 40, 80, 160, 250) connected to the line

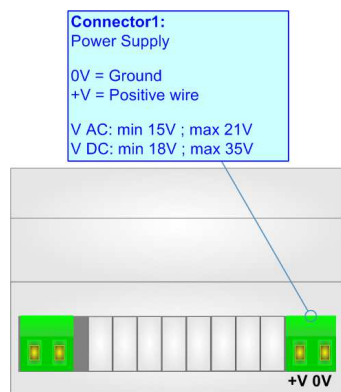

Caution: Not reverse the polarity power

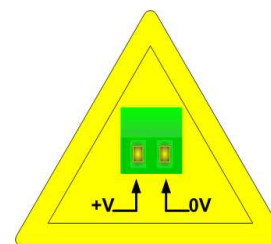

HD67056-B2-xxx
HD67056-MSTP-xxx

FUNCTION MODES:

The device has got two functions mode depending of the position of the 'Dip1 of Dip-Switch A':

- The first, with 'Dip1 of Dip-Switch A' at "OFF" position, is used for the normal working of the device.
- The second, with 'Dip1 of Dip-Switch A' at "ON" position, is used for upload the Project and/or Firmware.

For the operations to follow for the updating, see 'UPDATE DEVICE' section.

According to the functioning mode, the LEDs will have specifics functions, see 'LEDS' section.

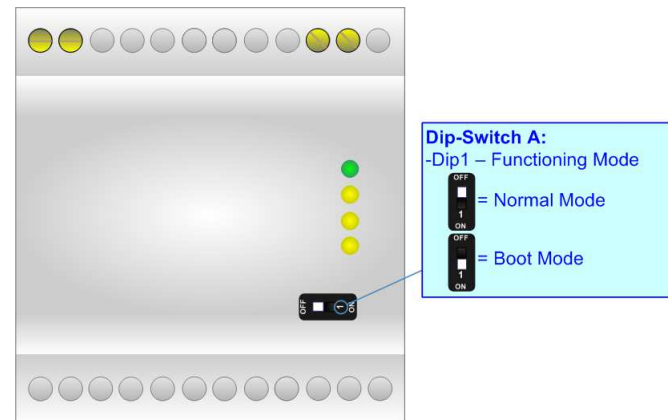

LEDS:

The device has got five LEDs that are used to give information of the functioning status.
The various meanings of the LEDs are described in the table below.

LED	Normal Mode	Boot Mode
1: Device State (green)	Blinks slowly (~1Hz)	Blinks quickly: Boot state Blinks very slowly (~0.5Hz): update in progress
2: Not used	OFF	Blinks quickly: Boot state Blinks very slowly (~0.5Hz): update in progress
3: M-Bus comm.	Blinks quickly when a reply to a M-Bus request arrives	Blinks quickly: Boot state Blinks very slowly (~0.5Hz): update in progress
4: BACnet comm.	Changes state when receive a correct BACnet request	Blinks quickly: Boot state Blinks very slowly (~0.5Hz): update in progress

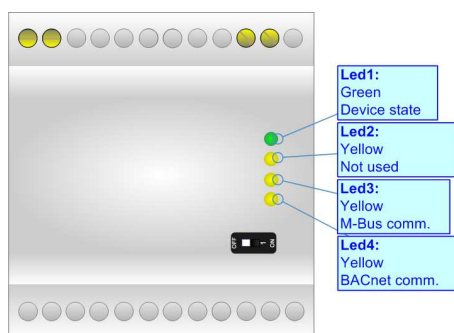

BACNET/IP (HD67056-B2-XXX SERIE):

BACnet/IP connection must be made using Connector3 of HD67056-B2 with at least a Category 5E cable. The maximum length of the cable should not exceed 100m. The cable has to conform to the T568 norms relative to connections in cat.5 up to 100 Mbps. To connect the device to an Hub/Switch is recommended the use of a straight cable, to connect the device to a PC/PLC/other is recommended the use of a cross cable.

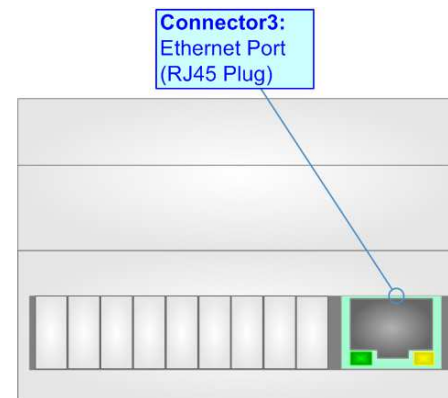

BACNET MS/TP (HD67056-MSTP-XXX SERIE):

BACnet MS/TP connection must be made using Connector6 of HD67056-MSTP. To terminate the RS485 line with a 120Ω resistor it is necessary to put ON dip 1, like in figure. The maximum length of the cable should be 1200m (4000 feet).

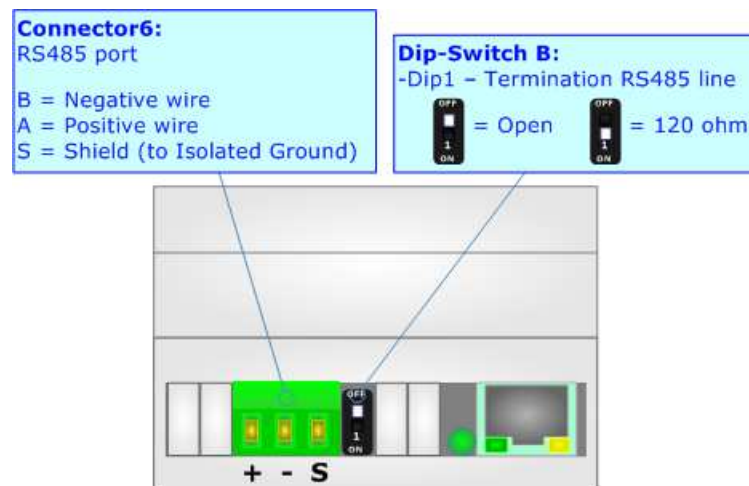

M-BUS:

The M-Bus is a unpolarized bus.

A two wire standard telephone cable (JYStY N*2*0.8 mm) is used as the transmission medium for the M-Bus. The maximum distance between a slave and the repeater is 350m; this length corresponds to a cable resistance of up 29 Ω . This distance applies for the standard configuration having Baud rates between 300 and 9600 Baud, and a maximum of 250 slaves. The maximum distance can be increased by limiting the Baud rate and using fewer slaves, but the bus voltage in the space state must at no point in a segment fall below 12V, because of the remote powering of the slaves. In the standard configuration the total cable length should not exceed 1000m, in order to meet the requirement of a maximum cable capacitance of 180nF. (*Taken from M-Bus specifics*)

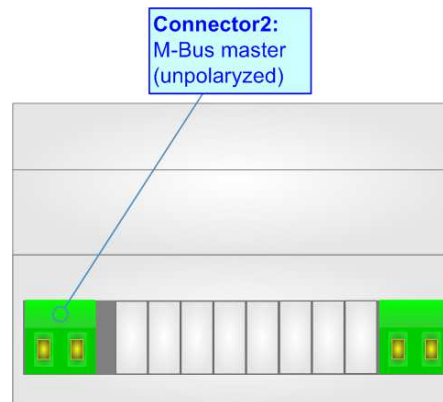

USE OF COMPOSITOR SW67056:

To configure the Converter, use the available software that runs with Windows called SW67056. It is downloadable on the site www.adfweb.com and its operation is described in this document. The software works with MSWindows (XP, Vista, Seven, 8, 10, 11; 32/64bit).

When launching the SW67056, the window below appears (Fig. 2).



Note:

It is necessary to have installed .Net Framework 4.

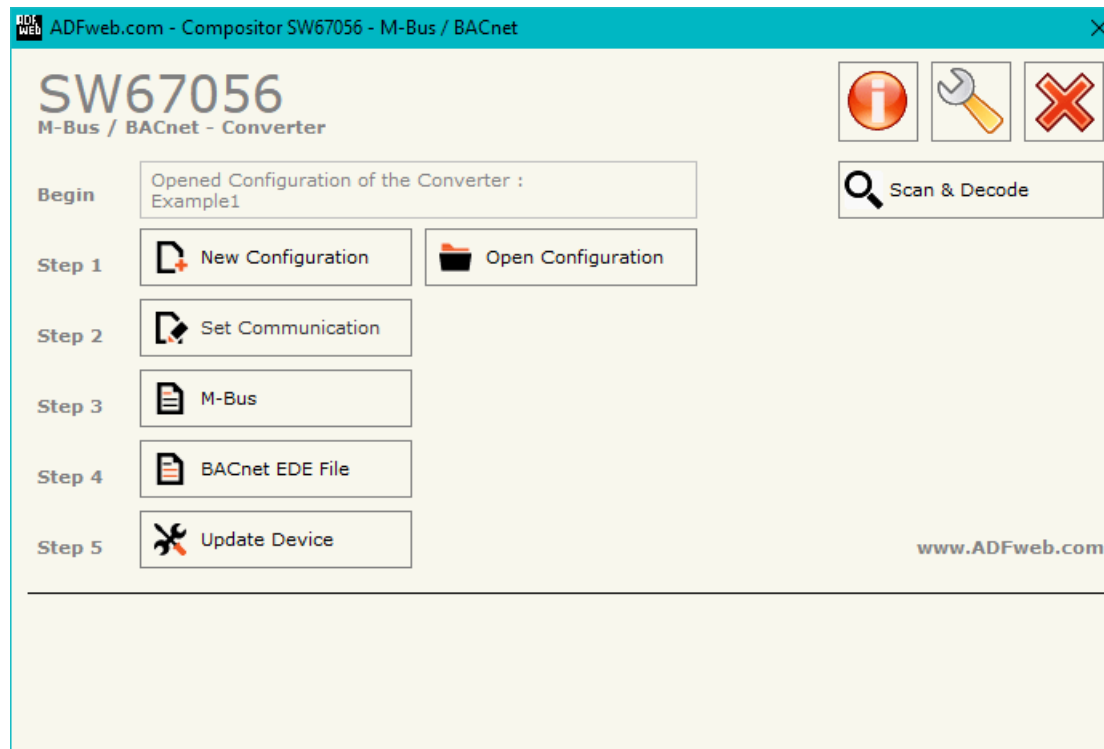
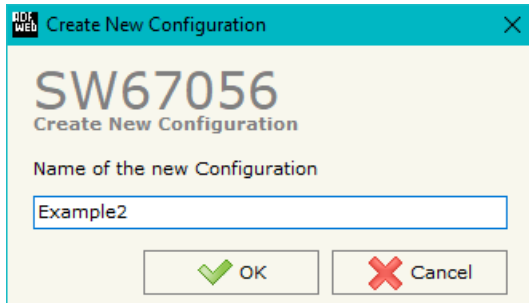

Figure 2: Main window for SW67056

NEW CONFIGURATION / OPEN CONFIGURATION:

The “**New Configuration**” button creates the folder which contains the entire device’s configuration.



A device’s configuration can also be imported or exported:

- To clone the configurations of a Programmable “M-Bus Master / BACnet Slave - Converter” in order to configure another device in the same manner, it is necessary to maintain the folder and all its contents;
- To clone a project in order to obtain a different version of the project, it is sufficient to duplicate the project folder with another name and open the new folder with the button “**Open Configuration**”.

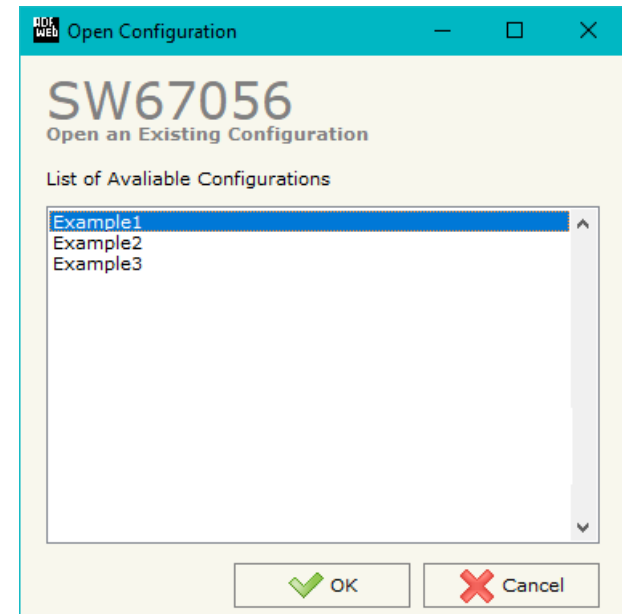

SOFTWARE OPTIONS:

By pressing the “**Settings**” () button there is the possibility to change the language of the software and check the updatings for the compositor.

In the section “Language” it is possible to change the language of the software.

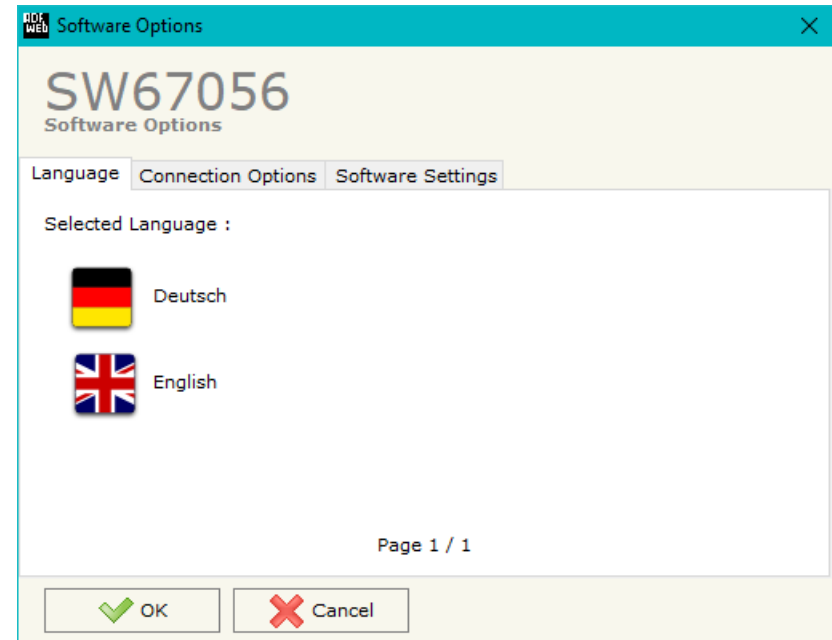
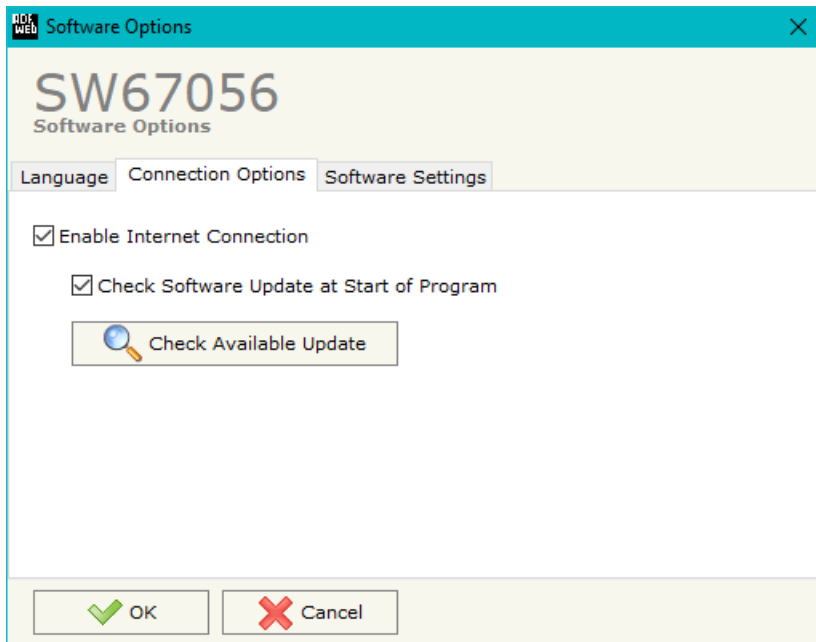

In the section “Connection Options”, it is possible to check if there are some updatings of the software compositor in ADFweb.com website. Checking the option “**Check Software Update at Start of Program**”, the SW67056 check automatically if there are updatings when it is launched.

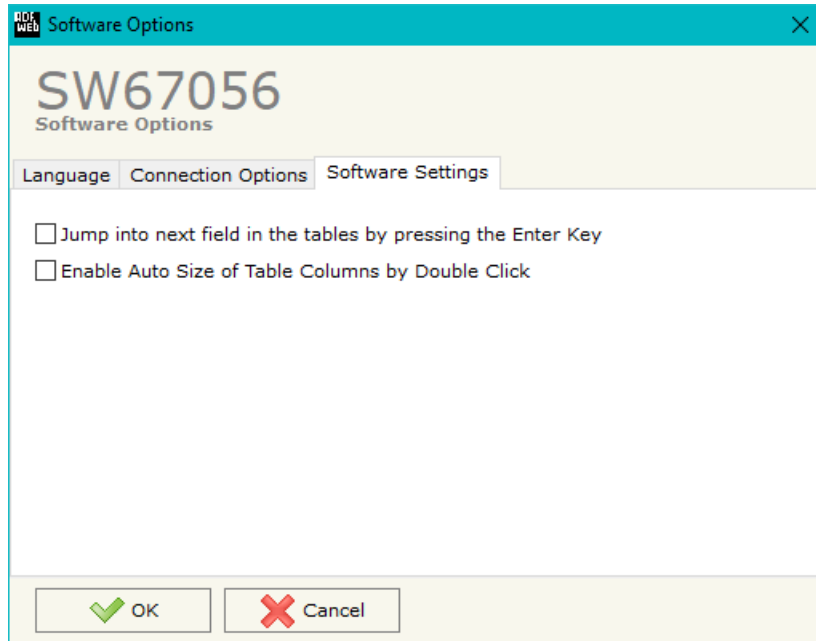

In the section "Software Settings", it is possible to enable/disable some keyboard's commands for an easier navigation inside the tables contained in the different sections of the software.

SET COMMUNICATION:

This section define the fundamental communication parameters of two buses, BACnet and M-Bus.

By Pressing the **"Set Communication"** button from the main window for SW67056 (Fig. 2) the window "Set Communication" appears (Fig. 3).

The window is divided in three sections, one for selecting the type of BACnet (in relation to the device used), one for the BACnet parameters and the other for the M-Bus parameters.

In the section "BACnet Type" is possible to select the type of BACnet to use from:

- BACnet/IP (uses Ethernet);
- BACnet MS/TP (uses RS485).

If selected "BACnet/IP" the means of the fields for "BACnet" are:

- In the fields **"IP ADDRESS"** the IP address of BACnet/IP side of the converter is defined;
- In the fields **"SUBNET Mask"** the SubNet Mask of BACnet/IP side of the converter is defined;
- In the fields **"GATEWAY"** the default gateway of the network is defined. This feature can be enabled or disabled pressing the Check Box field. This feature is used for going out of the net;
- In the field **"Port"** the port used for BACnet communication is defined. The default port used for BACnet communication is 47808, but is possible to insert any value (except 10000 and 10001);
- In the field **"BACnet Device Name"** the name of BACnet/IP side of the converter is defined;
- In the field **"Device Identifier"** the ID of BACnet/IP side of the converter is defined;
- If the field **"BACnet description up to 32 chars"** is checked, the description for the BACnet Objects can be up to 32 chars long.

The means of the fields for M-Bus are:

- In the field **"Baudrate"** the baudrate of the M-Bus line is defined;
- In the field **"Parity"** the parity of the M-Bus line is defined;
- If the field **"Cyclic Delay"** the delay (expressed in seconds) between two M-Bus scanning is defined;
- In the field **"Node State value when slave device is not present"** it is possible to insert the value to assign to the "Node State" when the Gateway doesn't find the interrogated M-Bus slave.

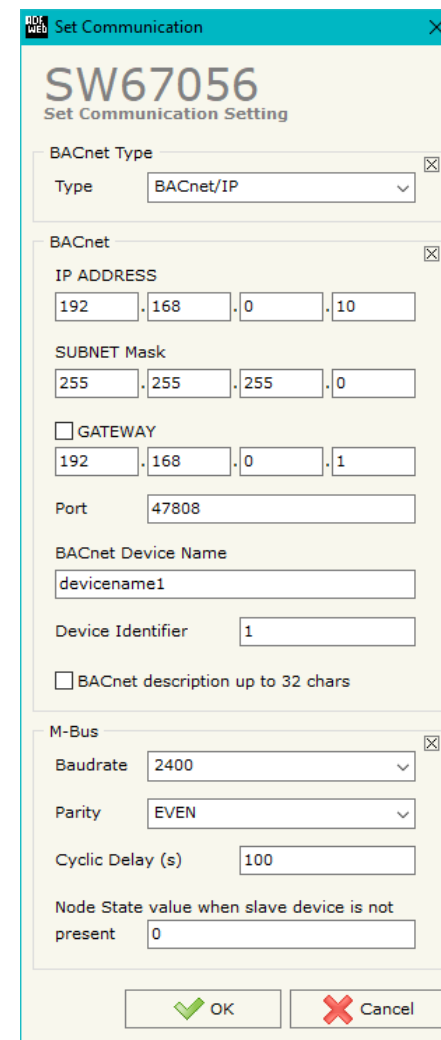

Figure 3a: "Set Communication" window

If selected "BACnet MS/TP", the means of the fields for "BACnet" are:

- In the field "**Baudrate**" the data rate of the BACnet line is defined;
- In the field "**Parity**" the parity of the line is defined;
- In the field "**BACnet Device Name**" the name to give to the BACnet node is defined;
- In the field "**MAC Address**" the MAC of BACnet node (from 0 to 254) is defined;
- The field "**Max Master**" specifies the highest allowable address for master nodes. The value shall be less than or equal to 127;
- The field "**Max Info Frames**" specifies the maximum number of information frames the node may send before it must pass the token;
- In the field "**Device Instance**" the of the BACnet MS/TP side of the converter is defined;
- In the field "**Network**" the BACnet MS/TP network number is defined;
- If the field "**BACnet description up to 32 chars**" is checked, the description for the BACnet Objects can be up to 32 chars long.

The means of the fields for M-Bus are:

- In the field "**Baudrate**" the baudrate of the M-Bus line is defined;
- In the field "**Parity**" the parity of the M-Bus line is defined;
- If the field "**Cyclic Delay**" the delay (expressed in seconds) between two M-Bus scanning is defined;
- In the field "**Node State value when slave device is not present**" it is possible to insert the value to assign to the "Node State" when the Gateway doesn't find the interrogated M-Bus slave.
- If the field "**Use Fic C Field**" is checked, it is possible to define a fixed C field in the M-Bus requests sent to the M-Bus meters;
- In the field "**Extension TimeOut ms**" the additional time for M-Bus polling to be added to the standard one is defined.

The means of the fields for the "Ethernet Update" section are:

- In the fields "**IP ADDRESS**" the IP address of the converter is defined;
- In the fields "**SUBNET Mask**" the SubNet Mask of the converter is defined;
- In the fields "**GATEWAY**" the default gateway of the network is defined. This feature can be enabled or disabled pressing the Check Box field. This feature is used for going out of the net.

These information are used for programming the Converter.

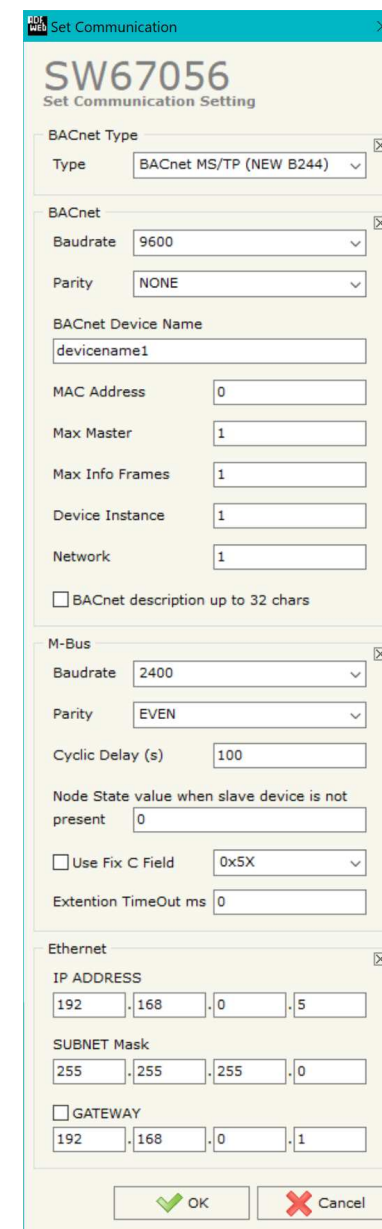

Figure 3b: "Set Communication" window

M-BUS

By Pressing the “**M-Bus**” button from the main window for SW67056 (Fig. 2) the window “M-Bus Network” appears (Fig. 4).

In the section “Nodes” it is possible to create the nodes of M-Bus line:

- In the field “**Description**” it is possible to write a short description of the node.

SECTION NODES (M-BUS NODES):

- In order to create a new node it is necessary to select which address use, selecting “**Primary ID**” or “**Secondary ID**”, to makes the requests and then insert the “Primary Address” (from 1 to 250) or the Secondary Address” (from 0 to 99999999) of M-Bus device.
- If the field “**Node State**” is checked, the Status byte of the M-Bus node is mapped into a BACnet Object.
- If the field “**Identification Number**” is checked, the Identification Number of the M-Bus node is mapped into a BACnet Object;
- In the field “**Swap Identification Num.**” it is possible to select the swap mode of the Identification Number. If swap isn’t necessary you have to select “None”; otherwise see the section “Swap Identification” (page 31) of this document for select the swap mode.
- If the field “**Convert BCD in Integer Identification Num.**” is checked, the converter converts the Identification Number that is normally expressed in BCD in a Integer value.
- If the field “**Send SND_NKE**” is checked, the converter sends the “SND_NKE” frame to start the communication.

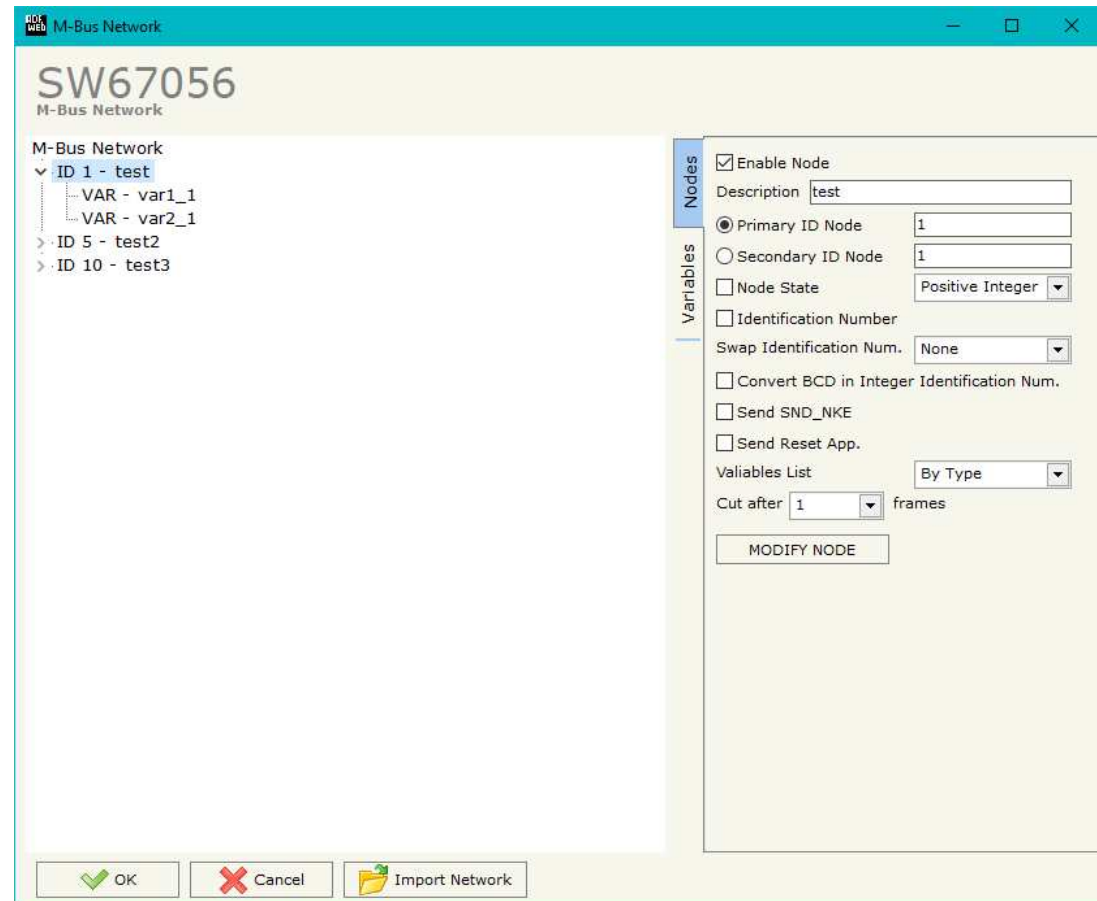

Figure 4: “M-Bus Network” window

- In the field "**Send Reset App.**" is checked, the converter sends the "Application Reset" command to the slave.
- In the field "**Variables List**" it is possible to select which type of variables definition to use. If is selected "By Type" it is necessary to fill all fields in the section Variables with the correct values; otherwise if "By Position" is selected, it is possible to insert the progressive number of the variable ned (page 27 for more information).
- In the field "**Cut after**" it is possible to select after how many frames stops data requests. It is used when the slave has got many data frames and you don't need to read all them.

After that, pressing the "**ADD NODE**" button, a new node appears in the left side of the window. In order to modify a created node it is necessary to select the desired node, change the wrong items and then press the "**MODIFY NODE**" button.

SECTION VARIABLES (BY TYPE):

Selecting the desired node it is possible to add a variable. In order to create a new variable it is necessary to fill these items:

- To use the created variable the field “**Enable Variable**” must be checked. If you have created a variable but for the moment it is unused it is possible to uncheck the field “Enable Variable” without delete it;
- In the field “**Description**” it is possible to write a description of the variable (it isn't a necessary information, it helps the readability of the tree of network);
- The field “**Type of Data**” is used to select the unit of measure;
- In the field “**VIF ASCII String**” insert the string of VIF. It is possible to use this field only if the “Type of Data” is “VIF is in ASCII”;
- In the field “**Function Field**” it is necessary to select the type of data;
- The field “**Dimension (bit)**” is used to select the dimension of the variable (8, 16, 24, 32, 32 real, 48, 64 bit, Variable Length);
- In the field “**Length(Variable Len)**” insert the length of the data in the case of the dimension is “Variable Length”;
- In the field “**Unit**” if it is necessary it is possible to select the unit of that variable. The Unit is used for indicates from which device the data come;
- In the field “**Storage Number**” if it is necessary it is possible to insert the value of storage counter of that variable. With this field the slave can indicate and transmit various stored counter states or historical values, in the order in which they occur;
- In the field “**Tariff**” if it is necessary it is possible to insert the value of the tariff of that variable. The Tariff is used for indicates from which device the data come;
- In the field “**VIFE**” it is possible to select a sub-type of “Type of Data”;

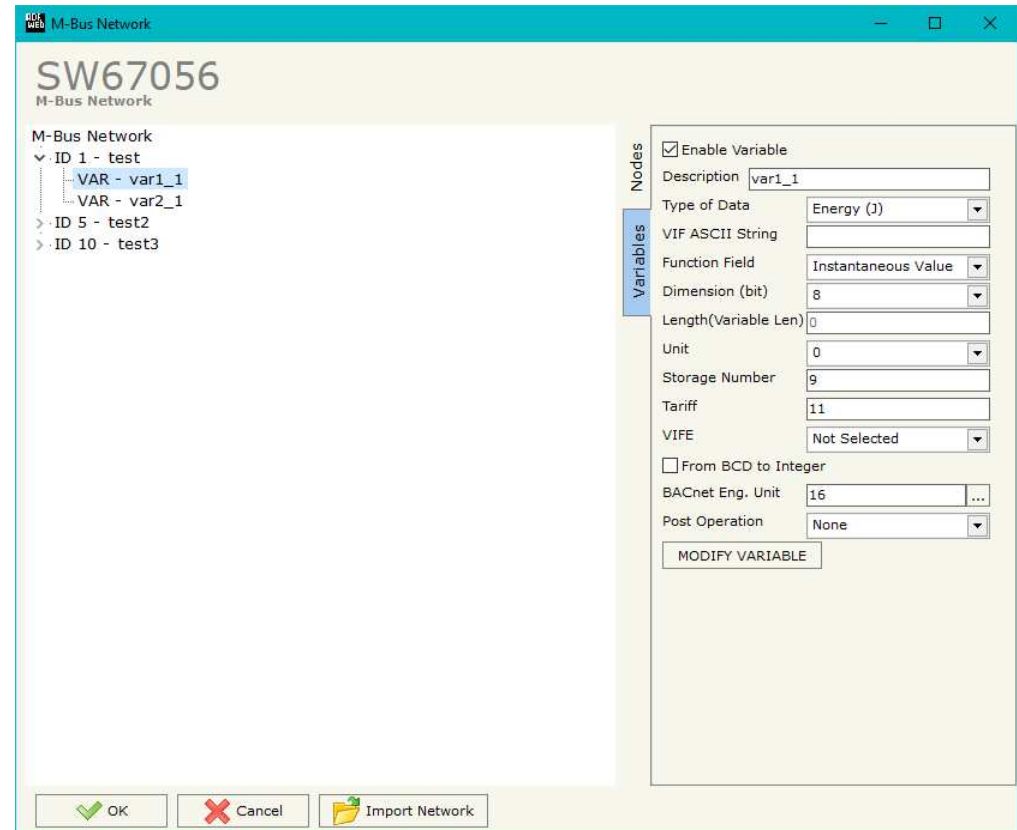

- If the field "**From BCD to Integer**" is checked the converter converts the BCD value of variable in Integer format. This happens only if the variable is in BCD format; if it isn't nothing changes.
- In the field "**BACnet Eng. Unit**" it is possible to select a Engineering Unit of the Object by pressing to the  button (see 'BACNET ENG. UNIT' section for more details);
- In the field "**Post Operation**" it is possible to select to do a math operation to the value.

Having completed this fields, to add the variable the button "**ADD VARIABLE**" must be pressed.

In order to modify a created variable it is necessary to select the desired variable, change the wrong items and then press the "**MODIFY VARIABLE**" button.

SECTION VARIABLES (BY POSITION):

Selecting the desired node it is possible to add a variable. In order to create a new variable it is necessary to fill these items:

- To use the created variable the field **“Enable Variable”** must be checked. If you have created a variable but for the moment it is unused it is possible to uncheck the field **“Enable Variable”** without delete it;
- In the field **“Description”** it is possible to write a description of the variable (it isn't a necessary information, it helps the readability of the tree of network);
- The field **“Dimension”** is used to select the dimension of the variable (8, 16, 24, 32, 32 real, 48, 64 bit, Variable Length);
- In the field **“Length(Variable Len)”** insert the length of the data in the case of the dimension is **“Variable Length”**;
- If the field **“From BCD to Integer”** is checked the converter converts the BCD value of variable in Integer format. This happens only if the variable is in BCD format; if it isn't nothing changes.
- In the field **“Position”** the position of the variable inside the M-Bus frame sent by the M-Bus slave is defined.
- In the field **“BACnet Eng. Unit”** it is possible to select a Engineering Unit of the Object by pressing to the  button (see 'BACNET ENG. UNIT' section for more details);
- In the field **“BACnet Data Type”** it is possible to select a type of Object used for saving the variable (see 'BACNET DATA TYPE' section for more details);
- In the field **“Post Operation”** it is possible to select to do a math operation to the value.

Having completed this fields, to add the variable the button **“ADD VARIABLE”** must be pressed.

In order to modify a created variable it is necessary to select the desired variable, change the wrong items and then press the **“MODIFY VARIABLE”** button.

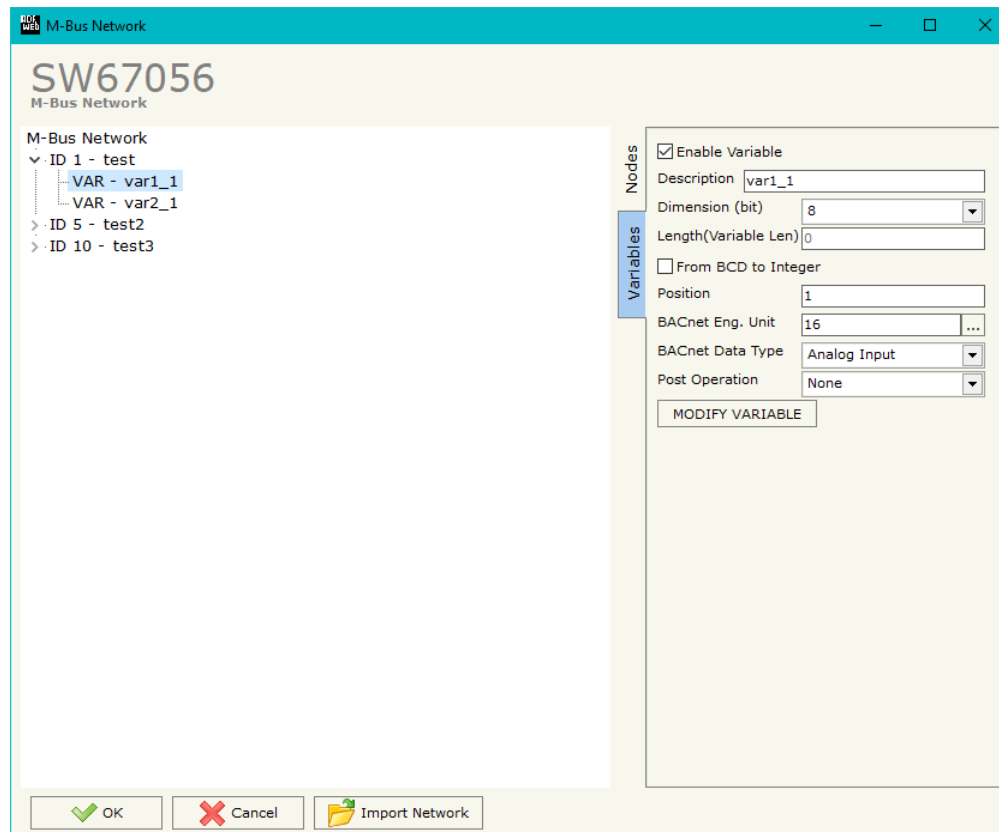

Example:

0x68 – Start Byte
 0xBD – L Field
 0xBD – L Field
 0x68 – Start Byte
 0x08 – C Field
 0x02 – A Field
 0x72 – CI Field

0x71 – Identification Number (Byte 4of4)
 0x65 – Identification Number (Byte 3of4)
 0x45 – Identification Number (Byte 2of4)
 0x28 – Identification Number (Byte 1of4)
 0x4D – Manufacturer (Byte 2of2)
 0x6A – Manufacturer (Byte 1of2)
 0x81 – Version
 0x04 – Medium
 0x3E – Access Number
 0x27 – Status
 0x00 – Signature (Byte 2of2)
 0x00 – Signature (Byte 1of2)

0x04 – DIF
 0x79 – VIF Identification
 0x00 – Data (Byte 4of4)
 0x00 – Data (Byte 3of4)
 0x00 – Data (Byte 2of4)
 0x00 – Data (Byte 1of4)

0x04 – DIF
 0x06 – VIF Energy
 0x00 – Data (Byte 4of4)
 0x00 – Data (Byte 3of4)
 0x00 – Data (Byte 2of4)
 0x00 – Data (Byte 1of4)

0x44 – DIF
 0x06 – VIF Energy
 0x00 – Data (Byte 4of4)
 0x00 – Data (Byte 3of4)
 0x00 – Data (Byte 2of4)
 0x00 – Data (Byte 1of4)

... Other Variables
 ...
 0x55 – Check Sum
 0x16 – Stop Byte

Fixed Data Header

Identification Number (or Secondary Address) put in the reserved fields if "**Identification Number**" is checked

Status of the meter put in the reserved field if "**Node State**" is checked

First Variable (1)

Second Variable (2)

Third Variable (3)

To be use in the "**Position**" field

COPY, PASTE AND DELETE ITEMS:

By pressing the right button of the mouse over an item (Variable or Node) it is possible to Copy, Paste and Delete.

It is possible to Copy a variable from a Node and copy it to another Node, or copy a Variable from a project and paste in another one.

It is also possible to copy an entire Node with all its Variables.



Note:

By pressing the “**Import Network**” button it is possible to import the file generated by the Analyzer HD67031.

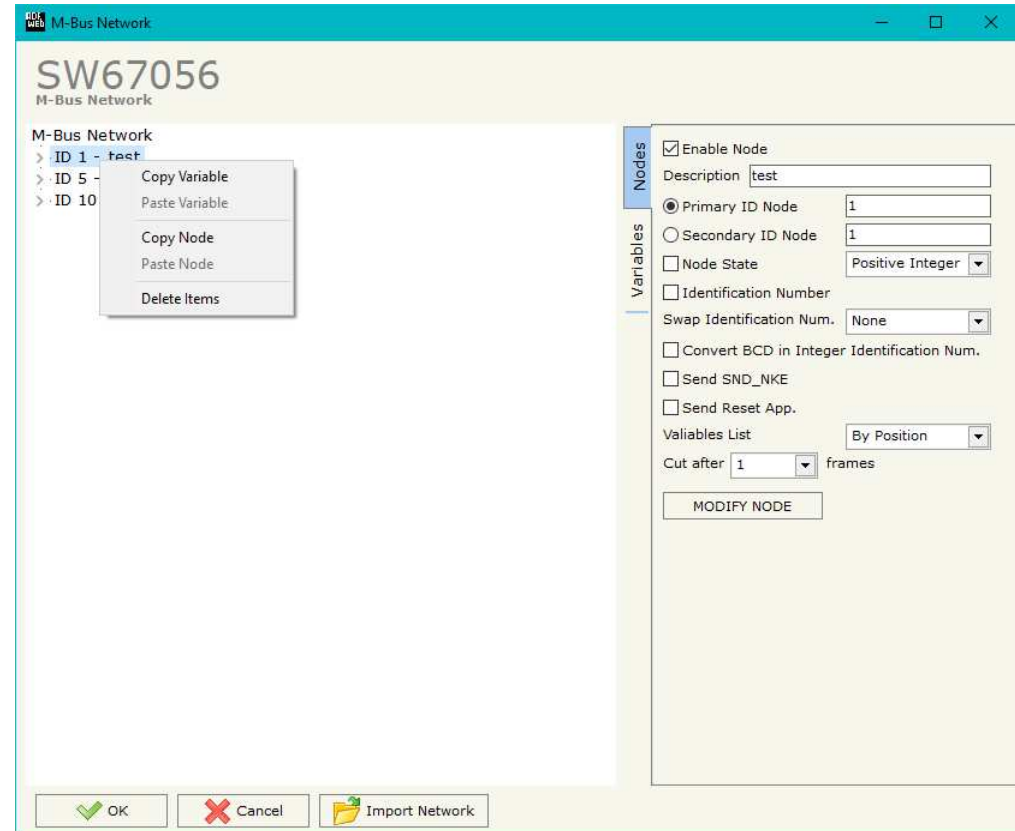

BACNET ENG. UNIT:

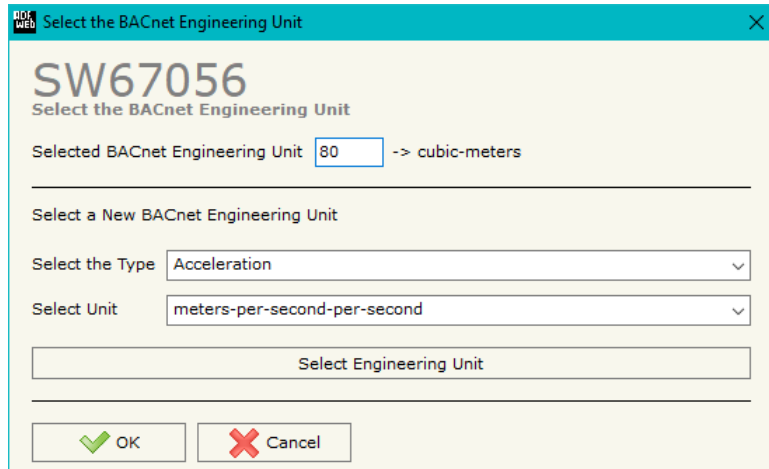



Figure 5: "Select the BACnet Engineering Unit" window

By pressing to  button the left window appears (Fig. 5).

Is possible to insert directly the Unit (using its unique number) by compiling the "Selected BACnet Engineering Unit" field; or by selecting with the fields "Select the Type" and "Select unit" the Type/Unit desired. If the second way is used, is necessary to press the "Select Engineering Unit" button for confirm the choice.

BACNET DATA TYPE:

When using the "Variables List → By Position" is necessary to select the Data Type of the variable. Is possible to select from these types: Analog Input (1), DateTime (3), Positive Integer (2), String (4). See the number between `[]` in the VIFE section for know the type to assign to a variable.

Possible choices for the fields used to create a variable:

Type of Data:

- |_Energy (Wh) [\[BACnet Data Type: 1\]](#)
- |_Energy (J) [\[1\]](#)
- |_Volume (m³) [\[1\]](#)
- |_Mass (Kg) [\[1\]](#)
- |_On Time [\[1\]](#)
- |_Operating Time [\[1\]](#)
- |_Power (W) [\[1\]](#)
- |_Power (J/h) [\[1\]](#)
- |_Volume Flow (m³/h) [\[1\]](#)
- |_Volume Flow Ext. (m³/min) [\[1\]](#)
- |_Volume Flow Ext. (m³/s) [\[1\]](#)
- |_Mass Flow (Kg/h) [\[1\]](#)
- |_Flow Temperature (°C) [\[1\]](#)
- |_Return Temperature (°C) [\[1\]](#)
- |_Temperature Difference (K) [\[1\]](#)
- |_External Temperature (°C) [\[1\]](#)
- |_Pressure (bar) [\[1\]](#)
- |_Averaging Duration [\[1\]](#)
- |_Actuality Duration [\[1\]](#)
- |_Type of data in VIFE
- |_Time Point [\[3\]](#)
- |_VIF is in ASCII [\[2\]](#)
- |_Unit for H.C.A. [\[2\]](#)
- |_Fabrication No [\[2\]](#)
- |_(Enhanced) Identification [\[2\]](#)
- |_Bus Address [\[2\]](#)

Function Field:

- |_Instantaneous Value
- |_Minimum Value
- |_Maximum Value
- |_Value During Error State

Dimension (bit):

- |_8
- |_16
- |_24
- |_32
- |_32 real
- |_48
- |_64
- |_Variable Length [\[4\]](#)

VIFE:

- _ Not Selected
- _ Credit of the nominal local legal currency units [2]
- _ Debit of the nominal local legal currency units [2]
- _ Access Number (transmission count) [2]
- _ Medium (as in fixed header) [2]
- _ Manufacturer (as in fixed header) [2]
- _ Parameter set identification [2]
- _ Model/Version [2]
- _ Hardware Version # [2]
- _ Firmware Version # [2]
- _ Software Version # [2]
- _ Customer Location [2]
- _ Customer [2]
- _ Access Code User [2]
- _ Access Code Operator [2]
- _ Access Code System Operator [2]
- _ Access Code Developer [2]
- _ Password [2]
- _ Error flags (binary) [2]
- _ Error mask [2]
- _ Digital Output (binary) [2]
- _ Digital Input (binary) [2]
- _ Baudrate [Baud] [2]
- _ response delay time [bittimes] [2]
- _ Retry [2]
- _ First storage # for cyclic storage [2]
- _ Last storage # for cyclic storage [2]
- _ Size of storage block [2]
- _ Storage interval [sec(s)..day(s)] [2]
- _ Storage interval month(s) [2]
- _ Storage interval year(s) [2]
- _ Duration since last readout[sec(s)..day(s)] [2]
- _ Start (date/time) of tariff [2]
- _ Duration of tariff (nn=01..11:min to day) [2]
- _ Period of tariff [sec(s) to day(s)] [2]
- _ Period of tariff months(s) [2]
- _ Period of tariff year(s) [2]
- _ dimensionless/ no VIF [2]
- _ Volts [1]
- _ Ampere [1]
- _ Reset counter [2]
- _ Comulation counter [2]
- _ Control signal [2]
- _ Day of week [2]
- _ Week number [2]
- _ Time point of day change [2]
- _ State of parameter activation [2]
- _ Special supplier information [2]
- _ Duration since last comulation [hour(s)..year(s)] [2]
- _ Operation time battery [hour(s)..year(s)] [2]
- _ Date and time of battery change [3]
- _ Energy MWh [1]
- _ Energy GJ [1]
- _ Volume [1]
- _ Mass [1]
- _ Volume 0,1 feet^3 [1]
- _ Volume 0,1 american gallon [1]
- _ Volume 1 american gallon [1]
- _ Volume flow 0,001 american gallon/min [1]
- _ Volume flow 1 american gallon/min [1]
- _ Volume flow 1 american gallon/h [1]
- _ Power MW [1]
- _ Power GJ/h [1]
- _ Flow Temperature [1]
- _ Return Temperature [1]
- _ Temperature Difference [1]
- _ External Temperature [1]
- _ Cold/Warm Temperature Limit °F [1]
- _ Cold/Worm Temperature Limit °C [1]
- _ Cumul. Count max power [1]

|_ per second [2]
 |_ per minute [2]
 |_ per hour [2]
 |_ per day [2]
 |_ per week [2]
 |_ per month [2]
 |_ per year [2]
 |_ per revolution/measurement [2]
 |_ increment per input pulse on input channel [2]
 |_ increment per output pulse on output channel [2]
 |_ per liter [2]
 |_ per m³ [2]
 |_ per kg [2]
 |_ per K (Kelvin) [2]
 |_ per kWh [2]
 |_ per GJ [2]
 |_ per kW [2]
 |_ per (K*I)(Kelvin*liter) [2]
 |_ per V (Volt) [2]
 |_ per A (Ampere) [2]
 |_ multiplied by sek [2]
 |_ multiplied by sek/V [2]
 |_ multiplied by sek/A [2]
 |_ start date(/time) of [2]
 |_ VIF contains uncorrected unit instead of corrected unit [2]
 |_ Accumulation only if positive contributions [2]
 |_ Accumulation of abs value only if negative contributions [2]
 |_ upper/lower limit value [2]

|_ # of exceeds of lower/upper limit [2]
 |_ Date(/time) of begin/end of first/last lower/upper limit exceed[2]
 |_ Duration of limit exceed [2]
 |_ Duration of first/last [2]
 |_ Date(/time) of first/last begin/end [2]
 |_ Multiplicative correction factor [2]
 |_ Additive correction constant * unit of VIF (offset) [2]
 |_ Multiplicative correction factor: 10³ [2]
 |_ future value [2]
 |_ next VIFE's and data of this block are manufacturer specific [2]
 |_ None [2]
 |_ Too many DIFE's [2]
 |_ Storage number not implemented [2]
 |_ Unit number not implemented [2]
 |_ Tariff number not implemented [2]
 |_ Function not implemented [2]
 |_ Data class not implemented [2]
 |_ Data size not implemented [2]
 |_ Too many VIFE's [2]
 |_ Illegal VIF-Group [2]
 |_ Illegal VIF-Exponent [2]
 |_ VIF/DIF mismatch [2]
 |_ Unimplemented action [2]
 |_ No data available (undefined value) [2]
 |_ Data overflow [2]
 |_ Data underflow [2]
 |_ Data error [2]
 |_ Premature end of record [2]

BACNET EDE FILE:

By Pressing the "**BACNET EDE FILE**" button from the main window for SW67056 (Fig. 2) it is possible to generate the EDE file to be imported into the BACnet Master.

Swap Identification:

This field is used for select the Swap mode of Identification Number.

At the moment there are these possibilities:

- None;
- Type 1.

Examples:

- Identification Number (Secondary Address): 12345678; Address Register 1000; Convert BCD in Integer Identification Num. not checked.

None	Type 1
1000: 0x1234	1000: 0x5678
1001: 0x5678	1001: 0x1234

- Identification Number (Secondary Address): 12345678; Address Register 1000; Convert BCD in Integer Identification Num. checked.

None	Type 1
1000: 0x00BC	1000: 0x614E
1001: 0x614E	1001: 0x00BC

UPDATE DEVICE:

By pressing the **"Update Device"** button, it is possible to load the created Configuration into the device; and also the Firmware, if necessary. This by using the Ethernet port.

If you don't know the actual IP address of the device you have to use this procedure:

- Turn OFF the Device;
- Put Dip1 of 'Dip-Switch A' in ON position;
- Turn ON the device
- Connect the Ethernet cable;
- Insert the IP **"192.168.2.205"**;
- Select which operations you want to do;
- Press the **"Execute update firmware"** button to start the upload;
- When all the operations are "OK" turn OFF the Device;
- Put Dip1 of 'Dip-Switch A' in OFF position;
- Turn ON the device.

If you know the actual IP address of the device, you have to use this procedure:

- Turn ON the Device with the Ethernet cable inserted;
- Insert the actual IP of the Converter;
- Select which operations you want to do;
- Press the **"Execute update firmware"** button to start the upload;
- When all the operations are "OK" the device automatically goes at Normal Mode.

At this point the configuration/firmware on the device is correctly updated.



Figure 6: "Update device" windows



Note:

When you receive the device, for the first time, you also have to update the Firmware in the HD67056 device.



Warning:

If Fig. 7 appears when you try to do the Update try these points before seeking assistance:

- Check if the serial COM port selected is the correct one;
- Check if the serial cable is connected between the PC and the device;
- Try to repeat the operations for the updating;
- Try with another PC;
- Try to restart the PC;
- Check the LAN settings;
- If you are using the program inside a Virtual Machine, try to use in the main Operating System;
- If you are using Windows Seven, Vista, 8, 10 or 11 make sure that you have the administrator privileges;
- In case you have to program more than one device, using the "UDP Update", you have to cancel the ARP table every time you connect a new device on Ethernet. For do this you have to launch the "Command Prompt" and write the command "arp -d". Pay attention that with Windows Vista, Seven, 8, 10 or 11 you have to launch the "Command Prompt" with Administrator Rights;
- Pay attention at Firewall lock.

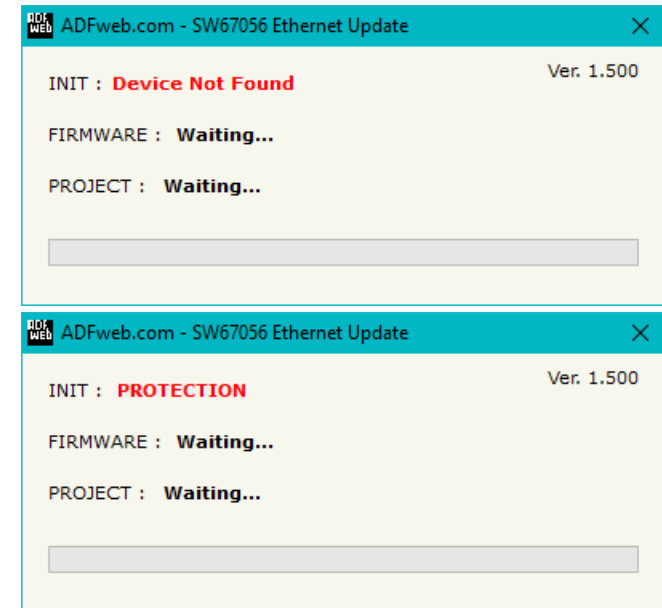

Figure 7: "Error" window



Warning:

In the case of HD67056 you have to use the software "SW67056": www.adfweb.com/download/filefold/SW67056.zip.

SCAN & DECODE FUNCTION:

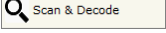
“SCAN & DECODE” functions are integrated in the configurator software SW67056. It is possible to access to these functions by simple click on the “ Scan & Decode” button.

It has the following characteristics:

- Possibility to scan M-Bus network;
- Automatic decode of M-Bus telegrams;
- Easy connection directly through the Ethernet port of the converters.

For the description of the function, it is possible to refer to this manual: www.adfweb.com/download/filefold/SCAN&DECODE_ENG.pdf

MECHANICAL DIMENSIONS:

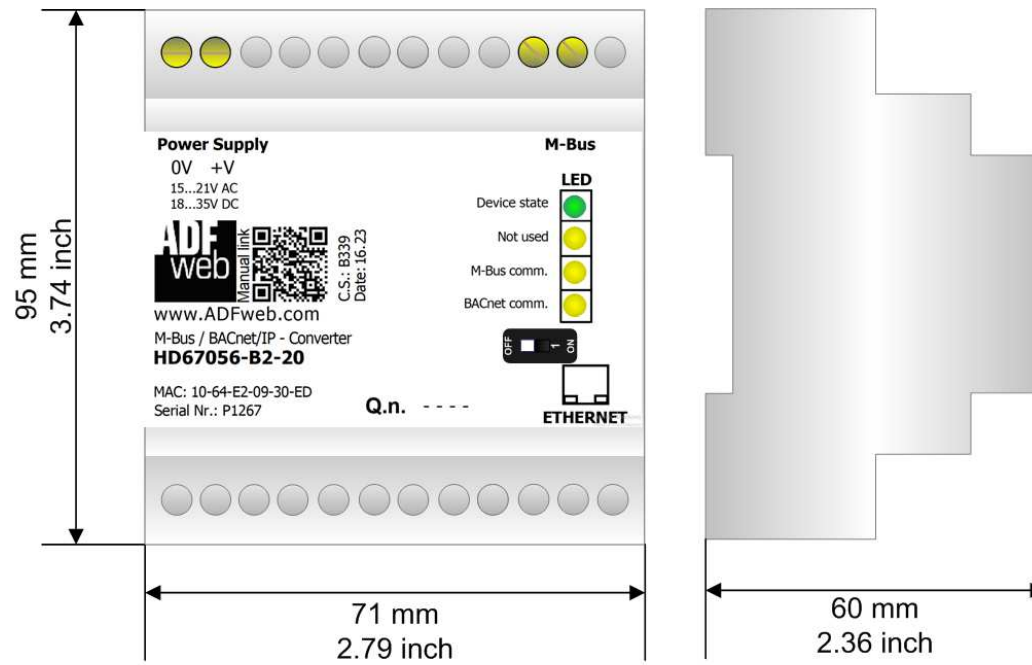

Housing: PVC
 Weight: 200g (Approx)

Figure 8: Mechanical dimensions scheme for HD67056

ORDERING INFORMATIONS:

The ordering part number is formed by a valid combination of the following:

HD67056 – B 2 – xxx

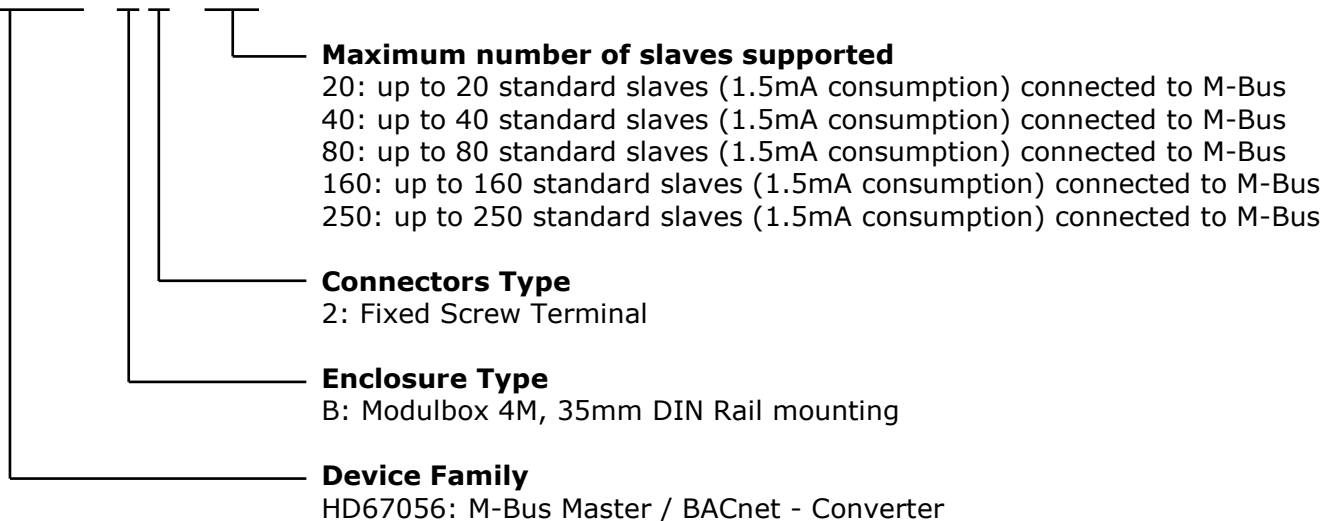

- Order Code: **HD67056-B2-20** - Converter M-Bus Master / BACnet/IP Slave (up to 20 slaves connected to M-Bus)
- Order Code: **HD67056-B2-40** - Converter M-Bus Master / BACnet/IP Slave (up to 40 slaves connected to M-Bus)
- Order Code: **HD67056-B2-80** - Converter M-Bus Master / BACnet/IP Slave (up to 80 slaves connected to M-Bus)
- Order Code: **HD67056-B2-160** - Converter M-Bus Master / BACnet/IP Slave (up to 160 slaves connected to M-Bus)
- Order Code: **HD67056-B2-250** - Converter M-Bus Master / BACnet/IP Slave (up to 250 slaves connected to M-Bus)
- Order Code: **HD67056-MSTP-20** - Converter M-Bus Master / BACnet MS/TP Slave (up to 20 slaves connected to M-Bus)
- Order Code: **HD67056-MSTP-40** - Converter M-Bus Master / BACnet MS/TP Slave (up to 40 slaves connected to M-Bus)
- Order Code: **HD67056-MSTP-80** - Converter M-Bus Master / BACnet MS/TP Slave (up to 80 slaves connected to M-Bus)
- Order Code: **HD67056-MSTP-160** - Converter M-Bus Master / BACnet MS/TP Slave (up to 160 slaves connected to M-Bus)
- Order Code: **HD67056-MSTP-250** - Converter M-Bus Master / BACnet MS/TP Slave (up to 250 slaves connected to M-Bus)

ACCESSORIES:

- Order Code: **APW020** - Power Supply for M-Bus Master device that supports up to 20 Slaves
- Order Code: **APW040** - Power Supply for M-Bus Master device that supports up to 40 Slaves
- Order Code: **APW080** - Power Supply for M-Bus Master device that supports up to 80 Slaves
- Order Code: **APW160** - Power Supply for M-Bus Master device that supports up to 160 Slaves
- Order Code: **APW250** - Power Supply for M-Bus Master device that supports up to 250 Slaves

DISCLAIMER:

All technical content within this document can be modified without notice. The content of the document is a under continual renewal. For losses due to fire, earthquake, third party access or other accidents, or intentional or accidental abuse, misuse, or use under abnormal conditions repairs are charged to the user. ADFweb.com S.r.l. will not be liable for accidental loss of use or inability to use this product, such as loss of business income. ADFweb.com S.r.l. shall not be liable for consequences of improper use.

OTHER REGULATIONS AND STANDARDS:**WEEE INFORMATION**

Disposal of old electrical and electronic equipment (as in the European Union and other European countries with separate collection systems).

— This symbol on the product or on its packaging indicates that this product may not be treated as household rubbish. Instead, it should be taken to an applicable collection point for the recycling of electrical and electronic equipment. If the product is disposed correctly, you will help prevent potential negative environmental factors and impact of human health, which could otherwise be caused by inappropriate disposal. The recycling of materials will help to conserve natural resources. For more information about recycling this product, please contact your local city office, your household waste disposal service or the shop where you purchased the product.

RESTRICTION OF HAZARDOUS SUBSTANCES DIRECTIVE

The device respects the 2002/95/EC Directive on the restriction of the use of certain hazardous substances in electrical and electronic equipment (commonly referred to as Restriction of Hazardous Substances Directive or RoHS).

CE MARKING

The product conforms with the essential requirements of the applicable EC directives.

WARRANTIES AND TECHNICAL SUPPORT:

For fast and easy technical support for your ADFweb.com SRL products, consult our internet support at www.adfweb.com. Otherwise contact us at the address support@adfweb.com

RETURN POLICY:

If while using your product you have any problem and you wish to exchange or repair it, please do the following:

- Obtain a Product Return Number (PRN) from our internet support at www.adfweb.com. Together with the request, you need to provide detailed information about the problem.
- Send the product to the address provided with the PRN, having prepaid the shipping costs (shipment costs billed to us will not be accepted).

If the product is within the warranty of twelve months, it will be repaired or exchanged and returned within three weeks. If the product is no longer under warranty, you will receive a repair estimate.



ADFweb.com S.r.l.
Via Strada Nuova, 17
IT-31010 Mareno di Piave
TREVISO (Italy)
Phone +39.0438.30.91.31
Fax +39.0438.49.20.99
www.adfweb.com

