

## User Manual

Revision 1.000  
English

### IEC 61850 Server / Modbus Slave - Converter

(Order Code: HD67734-2-A1 , HD67734-4-A1, HD67734-5-A1)

For Website information:

[www.adfweb.com?Product=HD67734](http://www.adfweb.com?Product=HD67734)

For Price information:

[www.adfweb.com?Price=HD67734-2-A1](http://www.adfweb.com?Price=HD67734-2-A1)

[www.adfweb.com?Price=HD67734-4-A1](http://www.adfweb.com?Price=HD67734-4-A1)

[www.adfweb.com?Price=HD67734-5-A1](http://www.adfweb.com?Price=HD67734-5-A1)

#### Benefits and Main Features:

- ⊕ Very easy to configure
- ⊕ Triple Electrical isolation
- ⊕ Temperature range: -40°C/+85°C (-40°F/+185°F)



For other IEC 61850 products see also the following link:

#### Converter IEC 61850 Server to

[www.adfweb.com?Product=HD67B82](http://www.adfweb.com?Product=HD67B82)  
[www.adfweb.com?Product=HD67620](http://www.adfweb.com?Product=HD67620)  
[www.adfweb.com?Product=HD67733](http://www.adfweb.com?Product=HD67733)  
[www.adfweb.com?Product=HD67734](http://www.adfweb.com?Product=HD67734)  
[www.adfweb.com?Product=HD67735](http://www.adfweb.com?Product=HD67735)  
[www.adfweb.com?Product=HD67736](http://www.adfweb.com?Product=HD67736)  
[www.adfweb.com?Product=HD67737](http://www.adfweb.com?Product=HD67737)  
[www.adfweb.com?Product=HD67738](http://www.adfweb.com?Product=HD67738)  
[www.adfweb.com?Product=HD67739](http://www.adfweb.com?Product=HD67739)  
[www.adfweb.com?Product=HD67740](http://www.adfweb.com?Product=HD67740)  
[www.adfweb.com?Product=HD67741](http://www.adfweb.com?Product=HD67741)  
[www.adfweb.com?Product=HD67743](http://www.adfweb.com?Product=HD67743)  
[www.adfweb.com?Product=HD67744](http://www.adfweb.com?Product=HD67744)  
[www.adfweb.com?Product=HD67745](http://www.adfweb.com?Product=HD67745)  
[www.adfweb.com?Product=HD67746](http://www.adfweb.com?Product=HD67746)  
[www.adfweb.com?Product=HD67747](http://www.adfweb.com?Product=HD67747)  
[www.adfweb.com?Product=HD67748](http://www.adfweb.com?Product=HD67748)  
[www.adfweb.com?Product=HD67749](http://www.adfweb.com?Product=HD67749)  
[www.adfweb.com?Product=HD67750](http://www.adfweb.com?Product=HD67750)  
[www.adfweb.com?Product=HD67751](http://www.adfweb.com?Product=HD67751)  
[www.adfweb.com?Product=HD67752](http://www.adfweb.com?Product=HD67752)  
[www.adfweb.com?Product=HD67753](http://www.adfweb.com?Product=HD67753)  
[www.adfweb.com?Product=HD67754](http://www.adfweb.com?Product=HD67754)  
[www.adfweb.com?Product=HD67755](http://www.adfweb.com?Product=HD67755)  
[www.adfweb.com?Product=HD67756](http://www.adfweb.com?Product=HD67756)  
[www.adfweb.com?Product=HD67765](http://www.adfweb.com?Product=HD67765)

**(PROFINET Master)**  
**(S7comm)**  
**(Modbus Master)**  
**(Modbus Slave)**  
**(Modbus TCP Master)**  
**(Modbus TCP Slave)**  
**(BACnet Master)**  
**(BACnet Slave)**  
**(CAN)**  
**(CANopen)**  
**(DeviceNet Master)**  
**(EtherNet/IP Master)**  
**(EtherNet/IP Slave)**  
**(J1939)**  
**(KNX)**  
**(MQTT)**  
**(NMEA0183)**  
**(NMEA2000)**  
**(PROFIBUS Master)**  
**(PROFIBUS Slave)**  
**(PROFINET Slave)**  
**(SNMP Manager)**  
**(SNMP Agent)**  
**(Serial)**  
**(Ethernet)**  
**(EnOcean)**

Do you have your customer protocol? Then go to:

[www.adfweb.com?Product=HD67003](http://www.adfweb.com?Product=HD67003)

Do you need to choose a device? Do you want help?

[www.adfweb.com?Cmd=helpme](http://www.adfweb.com?Cmd=helpme)



User Manual

**INDEX:**

|  | Page |
|--|------|
| INDEX                                  | 2    |
| UPDATED DOCUMENTATION                  | 2    |
| REVISION LIST                          | 2    |
| WARNING                                | 2    |
| TRADEMARKS                             | 2    |
| SECURITY ALERT                         | 3    |
| EXAMPLE OF CONNECTION                  | 4    |
| CONNECTION SCHEME                      | 5    |
| CHARACTERISTICS                        | 8    |
| CONFIGURATION                          | 8    |
| POWER SUPPLY                           | 9    |
| FUNCTION MODES                         | 10   |
| LEDS                                   | 11   |
| RS232                                  | 12   |
| RS485                                  | 12   |
| RS422                                  | 13   |
| ETHERNET                               | 13   |
| USE OF COMPOSITOR SW67734              | 14   |
| NEW CONFIGURATION / OPEN CONFIGURATION | 15   |
| SOFTWARE OPTIONS                       | 16   |
| SET COMMUNICATION                      | 18   |
| IEC 61850 ACCESS                       | 21   |
| TLS KNOWN CERTIFICATE                  | 22   |
| UPDATE DEVICE                          | 23   |
| MODBUS MAP                             | 25   |
| MECHANICAL DIMENSIONS                  | 27   |
| ORDERING INFORMATIONS                  | 28   |
| ACCESSORIES                            | 28   |
| DISCLAIMER                             | 29   |
| OTHER REGULATIONS AND STANDARDS        | 29   |
| WARRANTIES AND TECHNICAL SUPPORT       | 30   |
| RETURN POLICY                          | 30   |

**UPDATED DOCUMENTATION:**

Dear customer, we thank you for your attention and we remind you that you need to check that the following document is:

- Updated
- Related to the product you own

To obtain the most recently updated document, note the “document code” that appears at the top right-hand corner of each page of this document.

With this “Document Code” go to web page [www.adfweb.com/download/](http://www.adfweb.com/download/) and search for the corresponding code on the page. Click on the proper “Document Code” and download the updates.

**REVISION LIST:**

| Revision | Date       | Author | Chapter | Description   |
|----------|------------|--------|---------|---------------|
| 1.000    | 18/09/2020 | Ff     | All     | First Release |
|          |            |        |         |               |
|          |            |        |         |               |

**WARNING:**

ADFweb.com reserves the right to change information in this manual about our product without warning.  
ADFweb.com is not responsible for any error this manual may contain.

**TRADEMARKS:**

All trademarks mentioned in this document belong to their respective owners.

**SECURITY ALERT:****GENERAL INFORMATION**

To ensure safe operation, the device must be operated according to the instructions in the manual. When using the device, legal and safety regulation are required for each individual application. The same applies also when using accessories.

**INTENDED USE**

Machines and systems must be designed so the faulty conditions do not lead to a dangerous situation for the operator (i.e. independent limit switches, mechanical interlocks, etc.).

**QUALIFIED PERSONNEL**

The device can be used only by qualified personnel, strictly in accordance with the specifications. Qualified personnel are persons who are familiar with the installation, assembly, commissioning and operation of this equipment and who have appropriate qualifications for their job.

**RESIDUAL RISKS**

The device is state-of-the-art and is safe. The instruments can represent a potential hazard if they are inappropriately installed and operated by untrained personnel. These instructions refer to residual risks with the following symbol:



This symbol indicates that non-observance of the safety instructions is a danger for people that could lead to serious injury or death and / or the possibility of damage.

**CE CONFORMITY**

The declaration is made by our company. You can send an email to [support@adfweb.com](mailto:support@adfweb.com) or give us a call if you need it.

**EXAMPLES OF CONNECTION:**

**IEC 61850 / Modbus - Converter**  
HD67734-x-A1

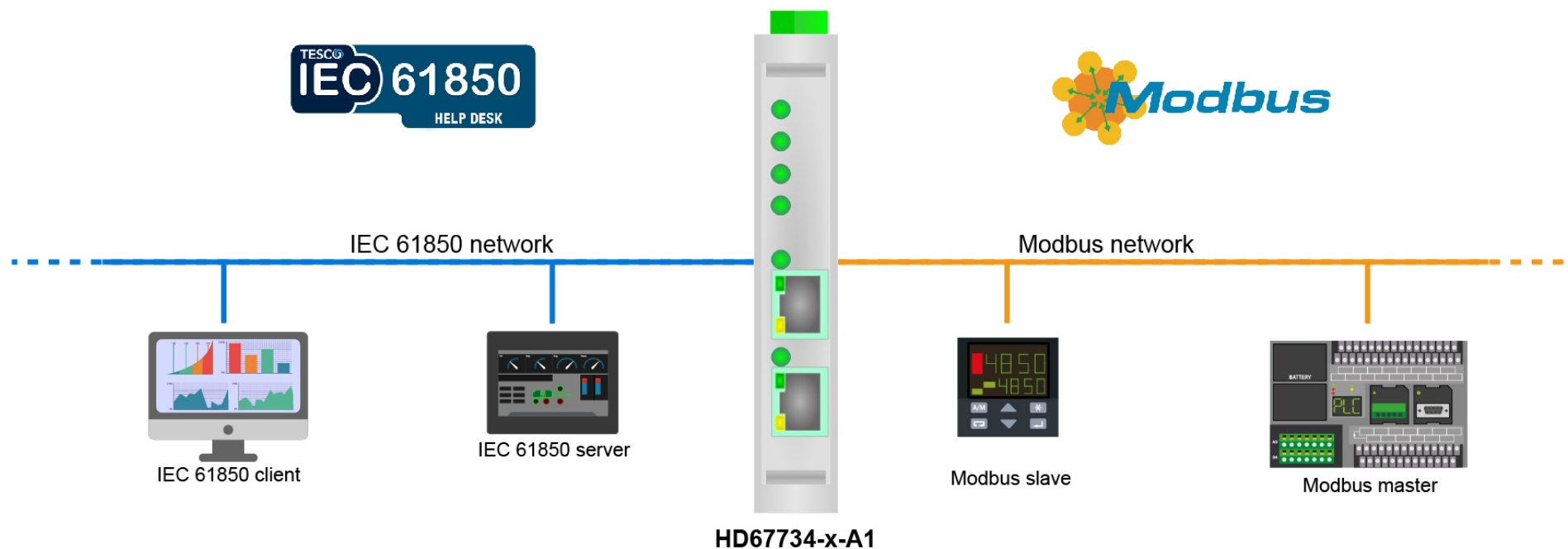

[ADFweb.com](http://ADFweb.com)



+39 0438 309 131



+39 349 440 9592



[support@adfweb.com](mailto:support@adfweb.com)

**CONNECTION SCHEME:**

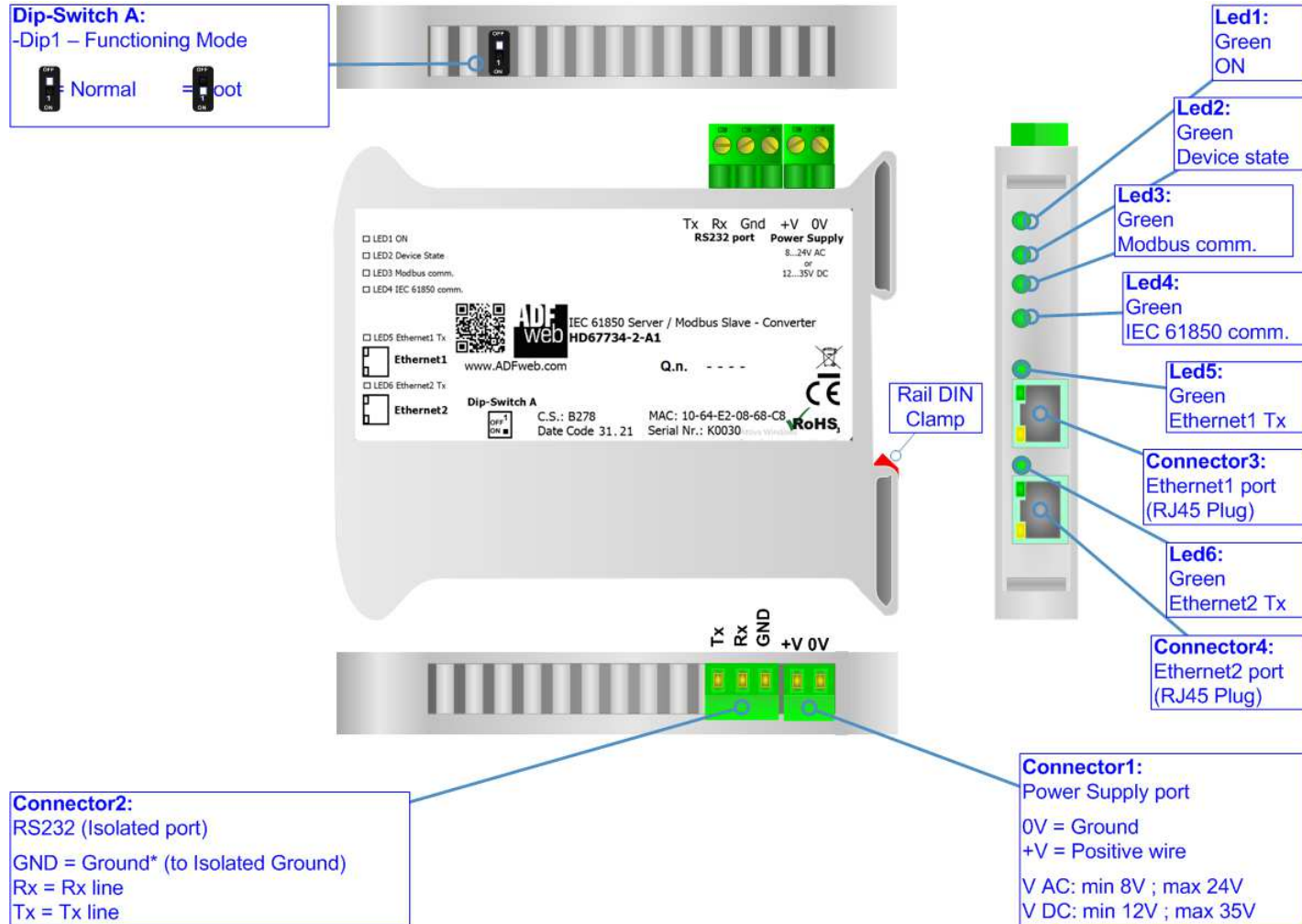

Figure 1a: Connection scheme for HD67734-2-A1

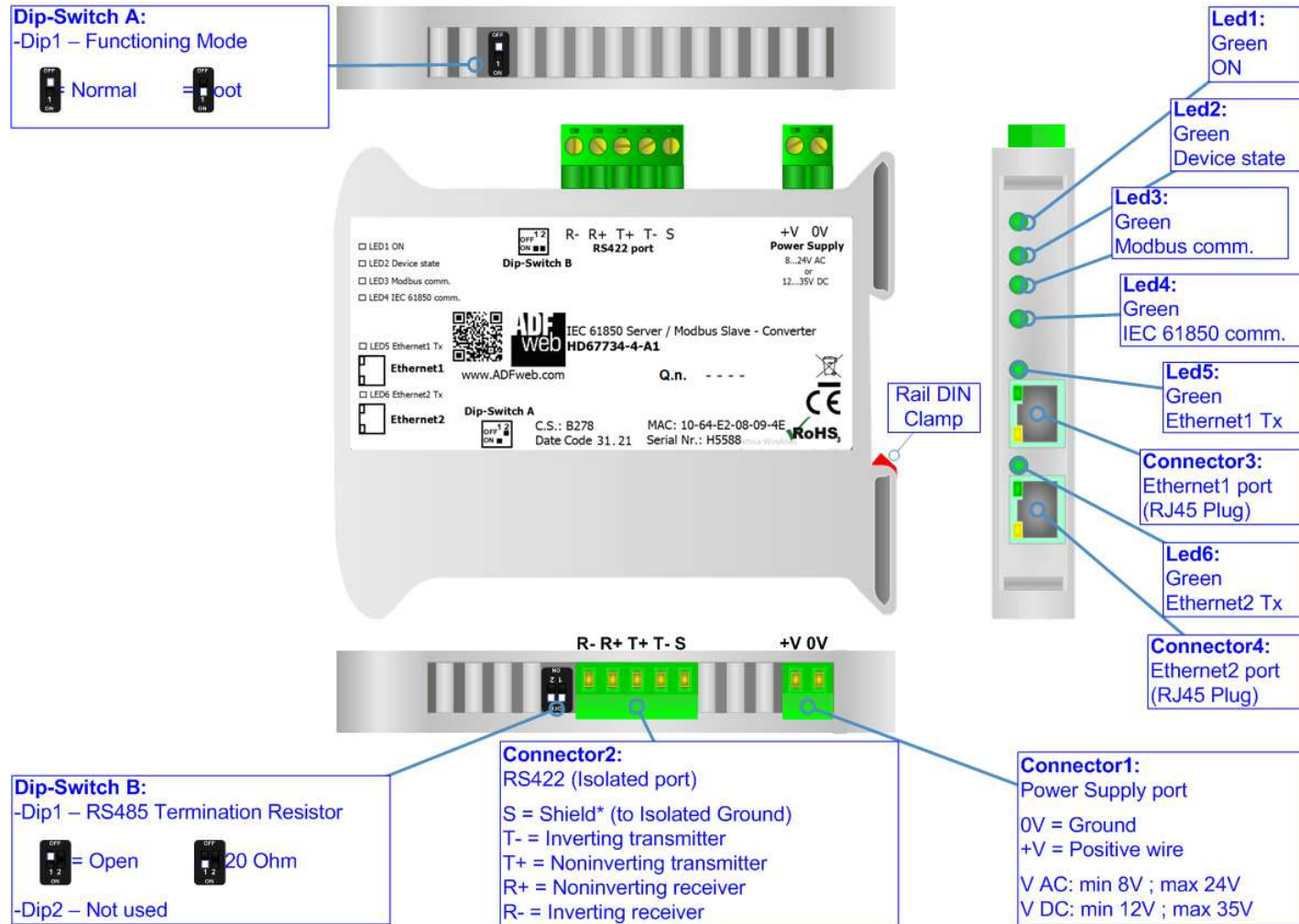

Figure 1b: Connection scheme for HD67734-4-A1

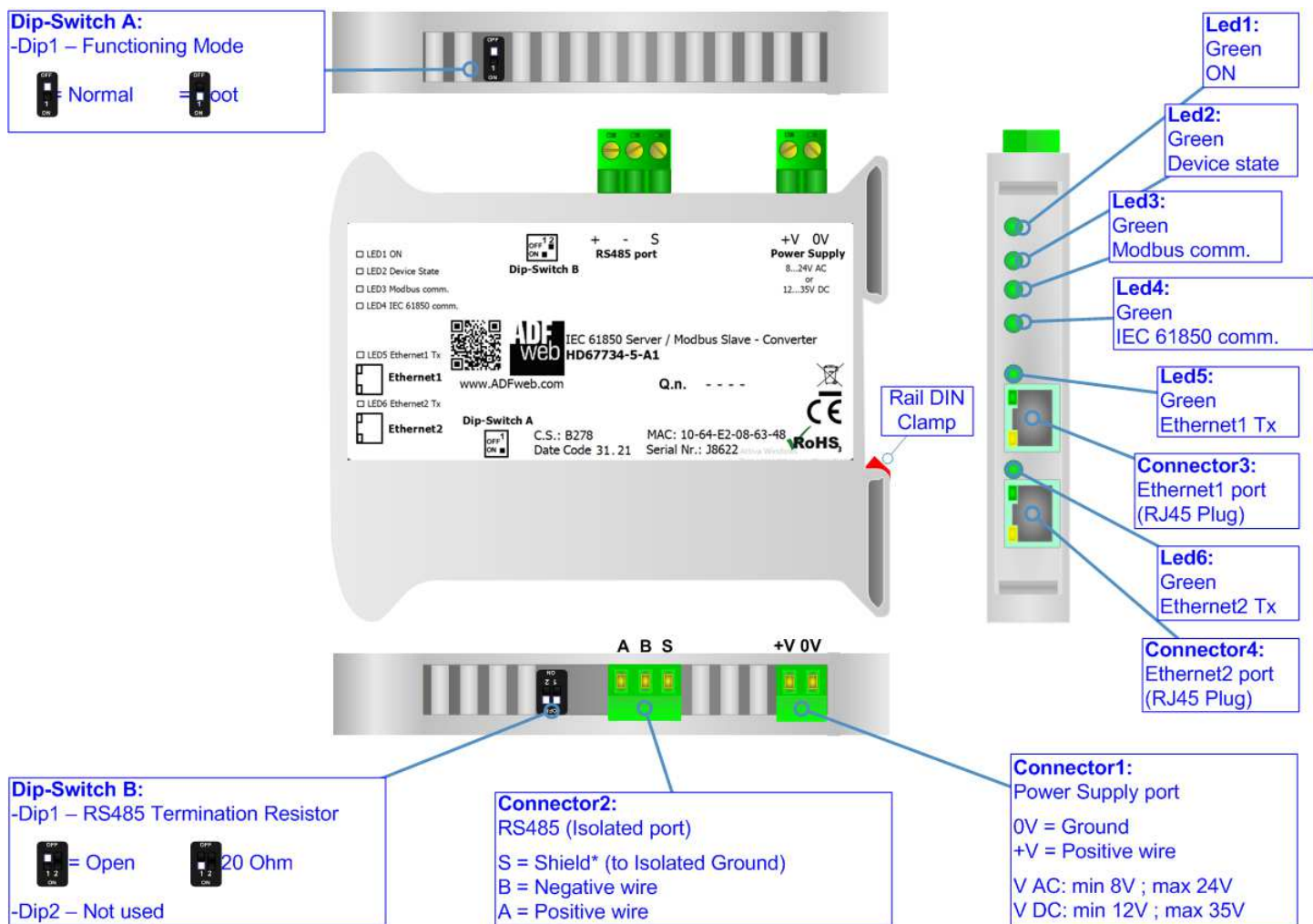

Figure 1c: Connection scheme for HD67734-5-A1

**CHARACTERISTICS:**

The HD67734-x-A1 are IEC 61850 / Modbus Slave - Converters.

It allows for the following characteristics:

- Triple isolation between RS232/RS485/RS422 - Power Supply, RS232/RS485/RS422 - Ethernet, Ethernet - Power Supply;
- Two-directional information between IEC 61850 bus and Modbus bus;
- Mountable on 35mm Rail DIN;
- Wide power supply input range: 8...24V AC or 12...35V DC;
- Wide temperature range: -40°C / 85°C [-40°F / +185°F].

**CONFIGURATION:**



You need Compositor SW67734 software on your PC in order to perform the following:

- Define the parameters of IEC 61850 line;
- Define the parameters of Modbus line;
- Define IEC 61850 variables that contains the data written by the Modbus Master;
- Define IEC 61850 variables that contains the data to make available to the Modbus Master;
- Update the device.



**POWER SUPPLY:**

The devices can be powered at 8...24V AC and 12...35V DC. For more details see the two tables below.

| VAC  |      | VDC  |      |
|---|------|---|------|
| Vmin  | Vmax | Vmin  | Vmax |
| 8V  | 24V  | 12V   | 35V  |

Consumption at 24V DC:

| Device       | Consumption [W/VA] |
|--------------|--------------------|
| HD67734-X-A1 | 3.5                |

**Caution: Do not reverse the polarity power**

**Connector1:**  
Power Supply port  
0V = Ground  
+V = Positive wire  
V AC: min 8V ; max 24V  
V DC: min 12V ; max 35V

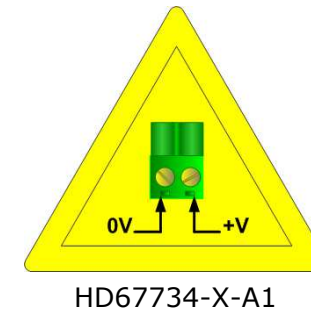
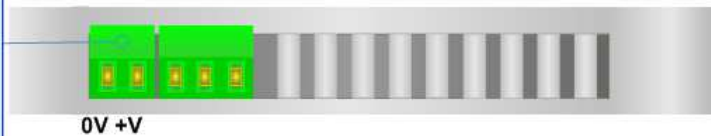

**FUNCTION MODES:**

The device has got two function modes depending on the position of the 'Dip1 of Dip-Switch A':

- The first, with 'Dip1 of Dip-Switch A' at "OFF" position, is used for the normal working of the device.
- The second, with 'Dip1 of Dip-Switch A' at "ON" position, is used for uploading the Project and/or Firmware.

For the operations to follow for the updating, see 'UPDATE DEVICE' section.

According to the functioning mode, the LEDs will have specific functions, see 'LEDS' section.

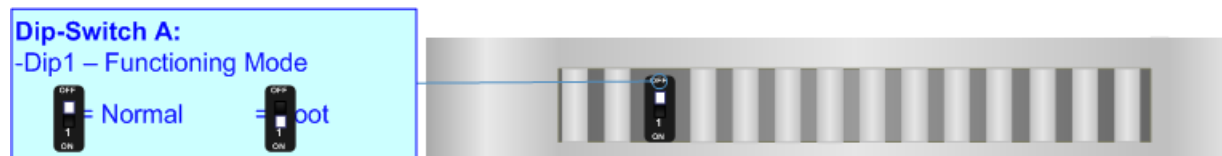

**LEDS:**

The device has got six LEDs that are used to give information about the functioning status.  
The various meanings of the LEDs are described in the table below.

| LED                                | Normal Mode   | Boot Mode   |
|------------------------------------|---|---|
| 1: ON [supply voltage ] (green)    | <b>ON:</b> Device powered<br><b>OFF:</b> Device not powered | <b>ON:</b> Device powered<br><b>OFF:</b> Device not powered                                 |
| 2: Device State (green)            | Blinks slowly (~1Hz)  | <b>Blinks quickly:</b> Boot state<br><b>Blinks very slowly (~0.5Hz):</b> update in progress |
| 3: Modbus communication (green)    | It blinks when a Modbus request is received                 | <b>Blinks quickly:</b> Boot state<br><b>Blinks very slowly (~0.5Hz):</b> update in progress |
| 4: IEC 61850 communication (green) | It blinks when a IEC 61850 request is received              | <b>Blinks quickly:</b> Boot state<br><b>Blinks very slowly (~0.5Hz):</b> update in progress |
| 5: Ethernet1 Tx (green)            | Blinks when is transmitting Ethernet frames                 | <b>Blinks quickly:</b> Boot state<br><b>Blinks very slowly (~0.5Hz):</b> update in progress |
| 6: Ethernet2 Tx (green)            | Blinks when is transmitting Ethernet frames                 | <b>Blinks quickly:</b> Boot state<br><b>Blinks very slowly (~0.5Hz):</b> update in progress |

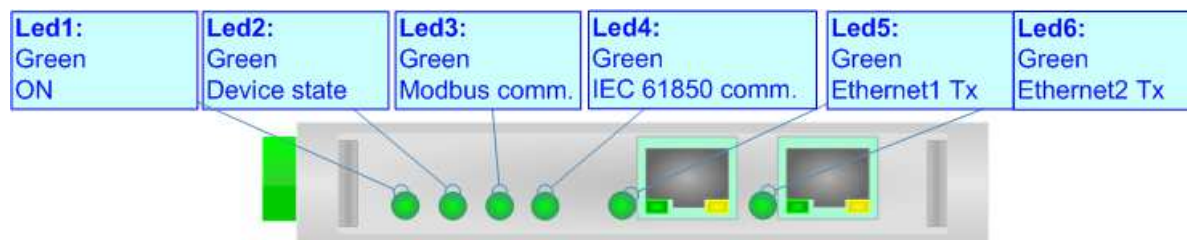

**RS232:**

The connection from RS232 socket to a serial port (example one from a personal computer) must be made with a Null Modem cable (a serial cable where the pins 2 and 3 are crossed).  
It is recommended that the RS232 cable not exceed 15 meters.

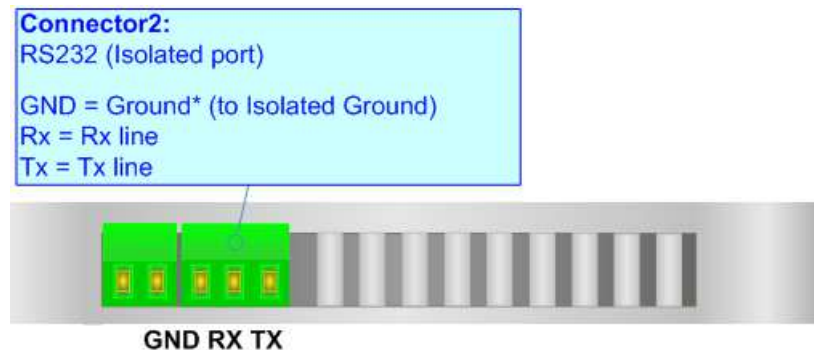

**RS485:**

For terminate the RS485 line with a 120Ω resistor it is necessary to put ON dip 1, like in figure.

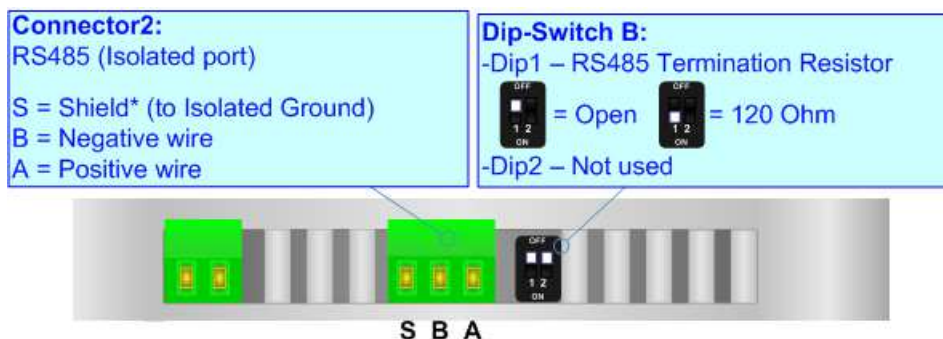

The maximum length of the cable should be 1200m (4000 feet).

Here some codes of cables:

- Belden: p/n 8132 - 2x 28AWG stranded twisted pairs conductor + foil shield + braid shield;
- Belden p/n 82842 - 2x 24AWG stranded twisted pairs conductor + foil shield + braid shield;
- Tasker: p/n C521 - 1x 24AWG twisted pair conductor + foil shield + braid shield;
- Tasker: p/n C522 - 2x 24AWG twisted pairs conductor + foil shield + braid shield.

**RS422:**

For terminate the RS485 line with a 120Ω resistor it is necessary to put ON dip 1 for T line and/or put ON dip 2 for R line, like in figure.

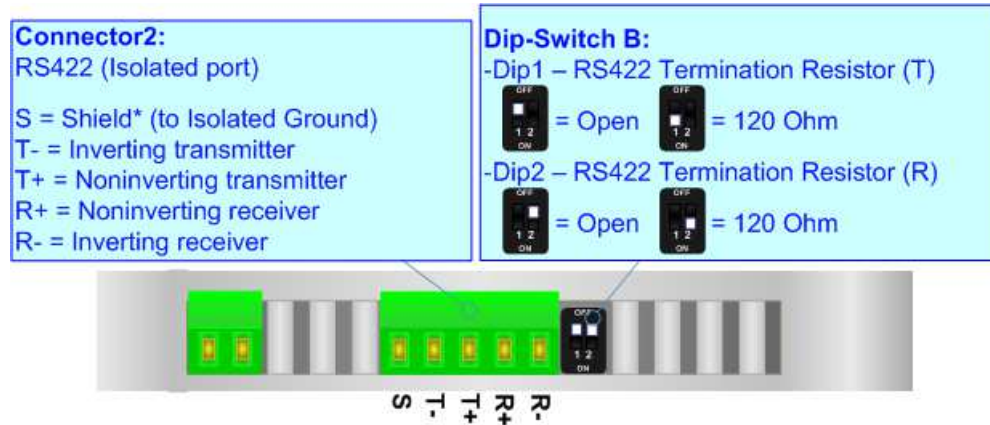

The maximum length of the cable should be 1200m (4000 feet).

**ETHERNET:**

IEC 61850 connection and the updating of the converters must be made using Connector3 and/or Connector4 of the HD67734-X-A1 with at least a Category 5E cable. The maximum length of the cable should not exceed 100m. The cable has to conform to the T568 norms relative to connections in cat.5 up to 100 Mbps. To connect the device to an Hub/Switch is recommended the use of a straight cable, to connect the device to a PC/PLC/other is recommended the use of a cross cable.

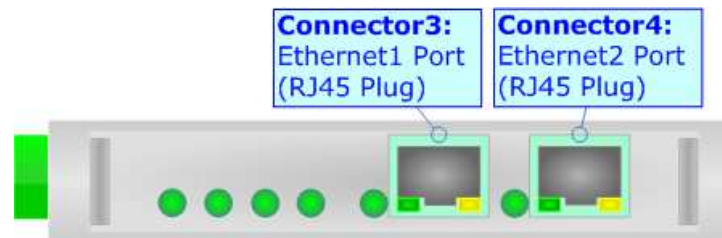

### USE OF COMPOSITOR SW67734:

To configure the Converter, use the available software that runs with Windows called SW67734. It is downloadable on the site [www.adfweb.com](http://www.adfweb.com) and its operation is described in this document. *(This manual is referenced to the last version of the software present on our web site).* The software works with MSWindows (XP, Vista, Seven, 8, 10; 32/64bit).

When launching the SW67734, the window below appears (Fig. 2).



**Note:**

It is necessary to have installed .Net Framework 4.

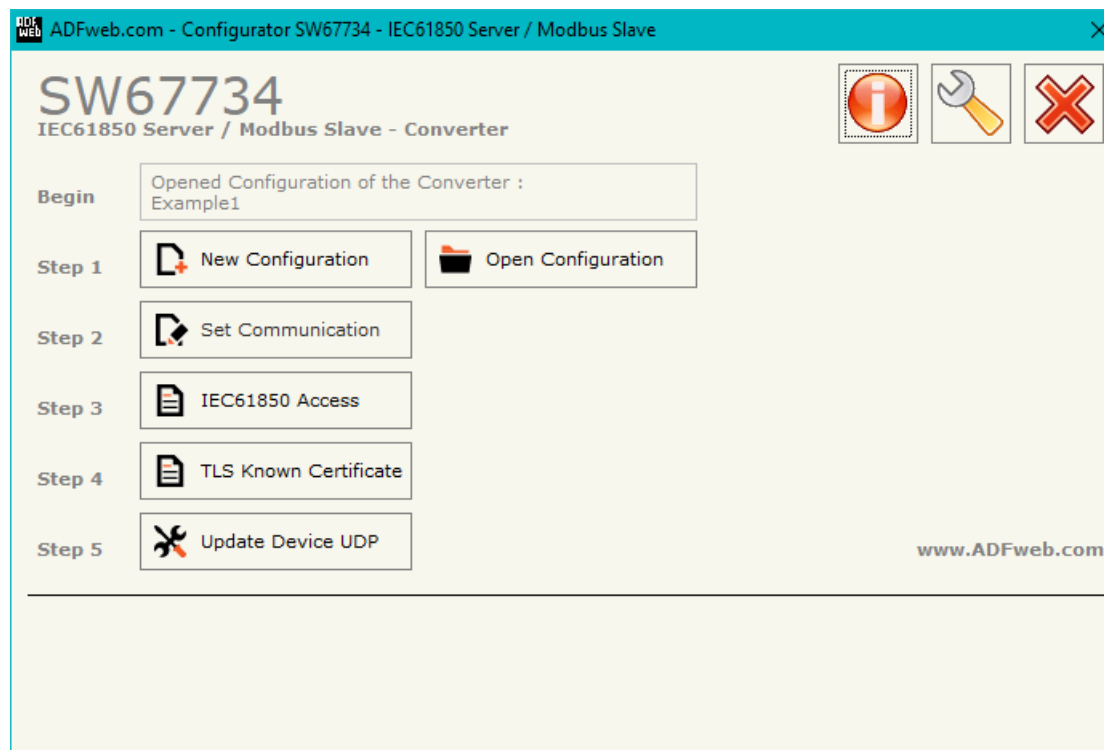
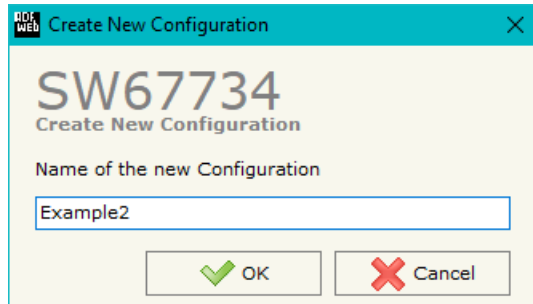

Figure 2: Main window for SW67734

**NEW CONFIGURATION / OPEN CONFIGURATION:**

The “**New Configuration**” button creates the folder which contains the entire device’s configuration.



A device’s configuration can also be imported or exported:

- To clone the configurations of a programmable “IEC 61850 Server / Modbus Slave - Converter” in order to configure another device in the same manner, it is necessary to maintain the folder and all its contents;
- To clone a project in order to obtain a different version of the project, it is sufficient to duplicate the project folder with another name and open the new folder with the button “**Open Configuration**”.

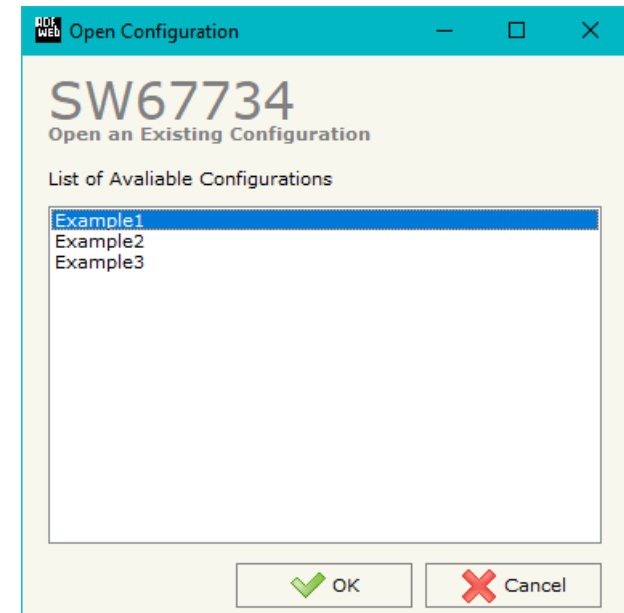

### SOFTWARE OPTIONS:

By pressing the “**Settings**” () button there is the possibility to change the language of the software and check the updatings for the compositor.

In the section “Language” it is possible to change the language of the software.

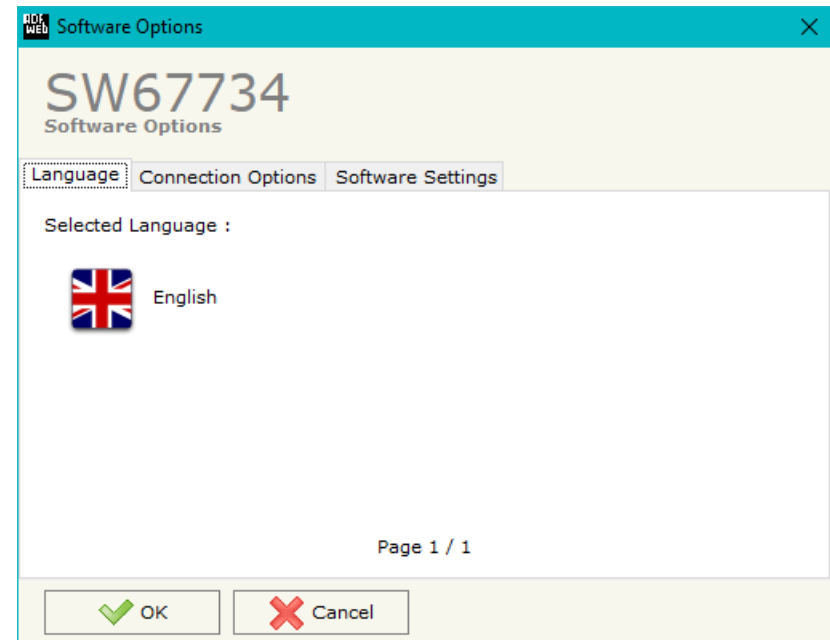
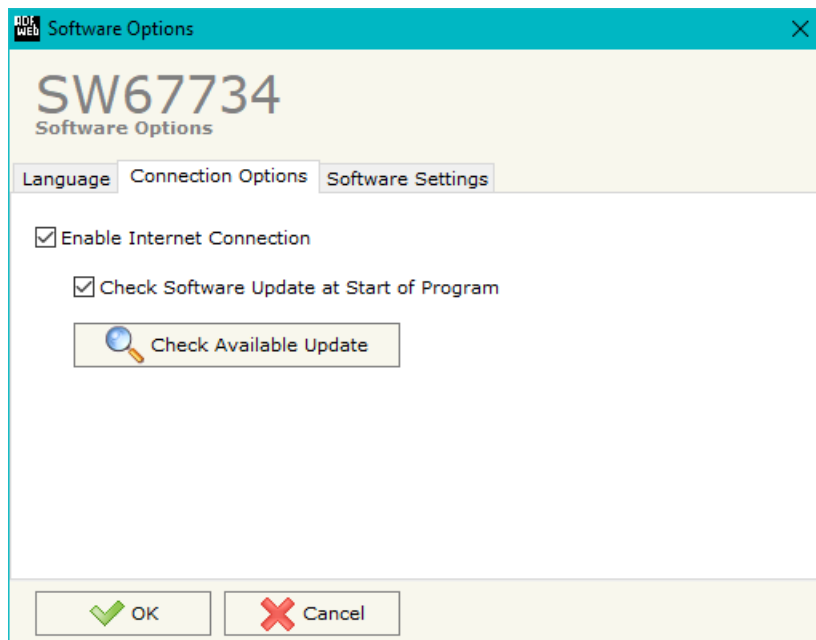

In the section “Connection Options”, it is possible to check if there are some updatings of the software compositor in ADFweb.com website. Checking the option “**Check Software Update at Start of Program**”, the SW67734 checks automatically if there are updatings when it is launched.



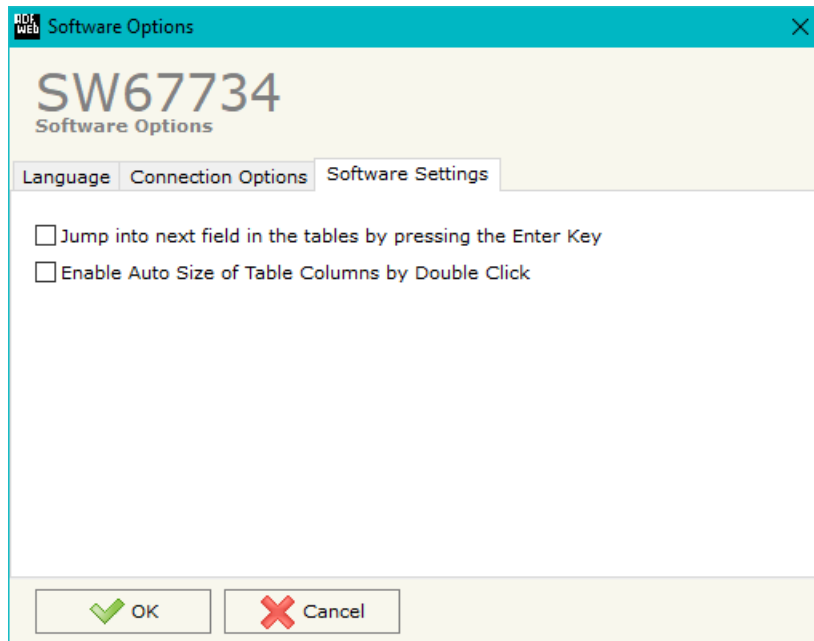

In the section "Software Settings", it is possible to enable/disable some keyboard's commands for an easier navigation inside the tables contained in the different sections of the software.

**SET COMMUNICATION:**

By Pressing the "**Set Communication**" button from the main window for SW67734 (Fig. 2) the window "Set Communication" appears (Fig. 3).

The window is divided in different sections in order to define the different parameters of the converter:

- IEC 61850 Server
- TLS (Transport Layer Security) Server
- Modbus Slave
- Ethernet

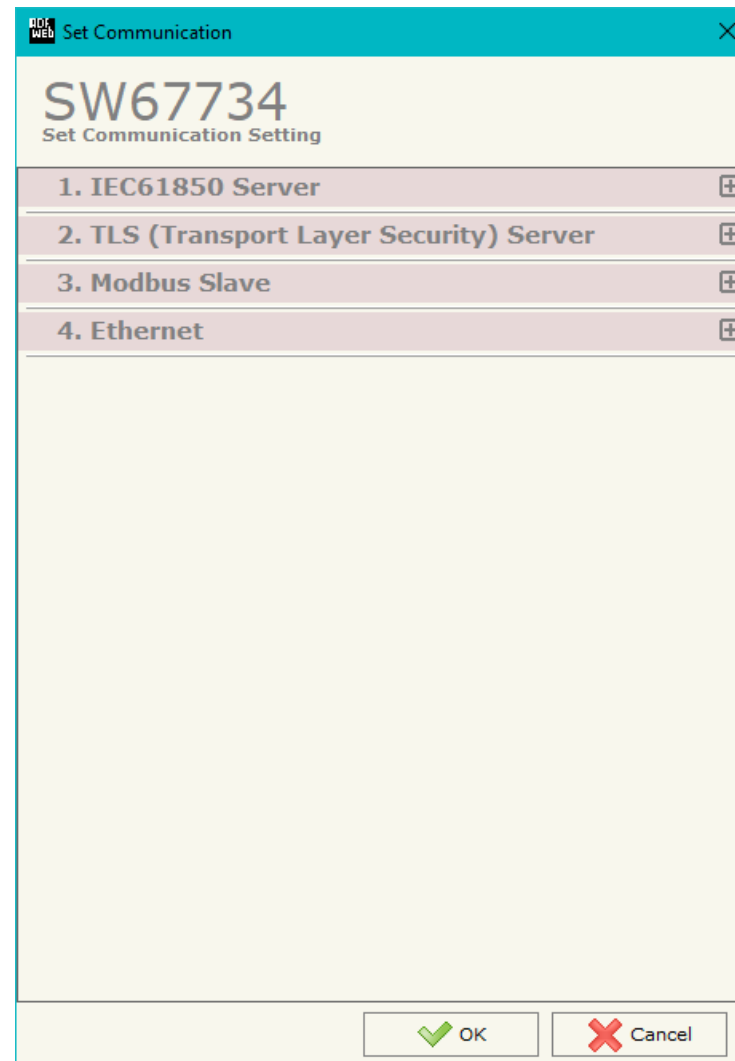

Figure 3a: "Set Communication" window

**IEC 61850 SERVER:**

This section is used to define the main parameters of IEC 61850 line. The means of the fields are:

- ➔ In the field "**Port**" the port used for IEC 61850 communication is defined;
- ➔ If the field "**Password**" the password used for accessing to IEC 61850 variables is defined.

**TLS (TRANSPORT LAYER SECURITY) SERVER**

This section is used to define the main parameters of TLS protocol. The means of the fields are:

- ➔ If the field "**Enable TLS**" is checked, the TLS protocol for secure connection is enabled;
- ➔ In the field "**Key**" the key for the authentication is defined;
- ➔ In the field "**Key Password**" the password for decrypting the key is defined;
- ➔ In the field "**Server Certificate**" the certificate for the server is defined;
- ➔ In the field "**Root Certificate**" the root of the server is defined;
- ➔ If the field "**Enable Only Known Certificates**" is checked, the converter will accept just connection from known Clients (defined in the section "TLS Known Certificate").

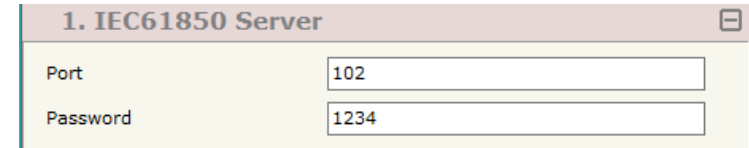

Figure 3b: "Set Communication → IEC 61850 Server" window

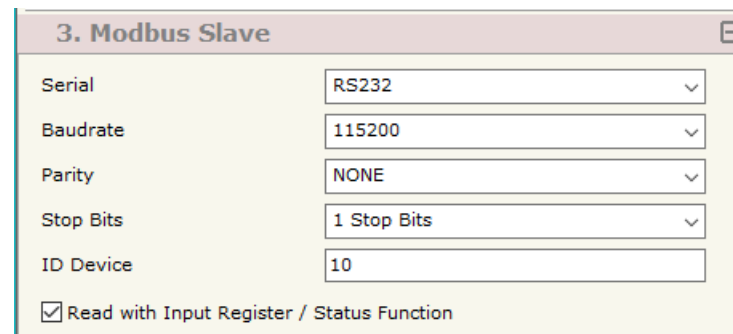

Figure 3c: "Set Communication → TLS" window

### **MODBUS SLAVE:**

This section is used to define the main parameters of Modbus line. The means of the fields are:

- In the field "**Serial**" the serial port to use is defined;
- In the field "**Baudrate**" the baudrate for the serial line is defined;
- In the field "**Parity**" the parity of the serial line is defined;
- In the field "**Stop Bits**" the number of Stop Bits of the serial line is defined;
- In the field "**ID Device**" the ID of Modbus side of the converter is defined;
- If the field "**Read with Input Register / Status Function**" is checked, it is possible to read the Input bytes of IEC61850 side with Input Registers (Function 04) and write the Output bytes of IEC61850 side with Holding Registers (Function 06/16). The Output bytes are readable with Function 03. Otherwise, only Holding Registers will be used and the Output bytes of IEC61850 side cannot be read back.



| 3. Modbus Slave  |             |
|--|-------------|
| Serial   | RS232       |
| Baudrate   | 115200      |
| Parity   | NONE        |
| Stop Bits  | 1 Stop Bits |
| ID Device  | 10          |
| <input checked="" type="checkbox"/> Read with Input Register / Status Function |             |

Figure 3d: "Set Communication → Modbus Slave" window

### **ETHERNET:**

This section is used to define the general parameters of Ethernet. The means of the fields are:

- In the field "**IP Address**" the IP address of the converter is defined;
- In the field "**SubNet Mask**" the Subnet Mask of the converter is defined;
- In the field "**Gateway**" the default gateway of the net is defined. This feature can be enabled or disabled pressing the Check Box field. This feature is used for going out of the net.

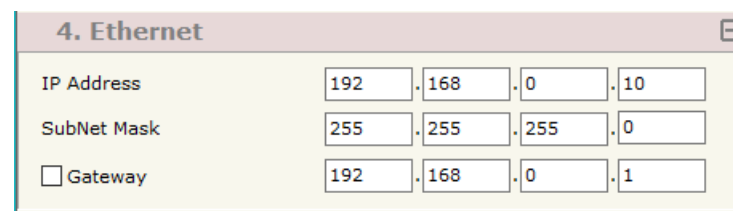

| 4. Ethernet                      |                     |
|----------------------------------|---------------------|
| IP Address                       | 192 . 168 . 0 . 10  |
| SubNet Mask                      | 255 . 255 . 255 . 0 |
| <input type="checkbox"/> Gateway | 192 . 168 . 0 . 1   |

Figure 3e: "Set Communication → Ethernet" window

**IEC 61850 ACCESS:**

By Pressing the “**IEC 61850 Access**” button from the main window for SW67734 (Fig. 2) the window “Set Variables Access for IEC 61850” appears (Fig. 4).

This section is used to define the IEC 61850 variables from/to which take/map the data of Modbus Master.

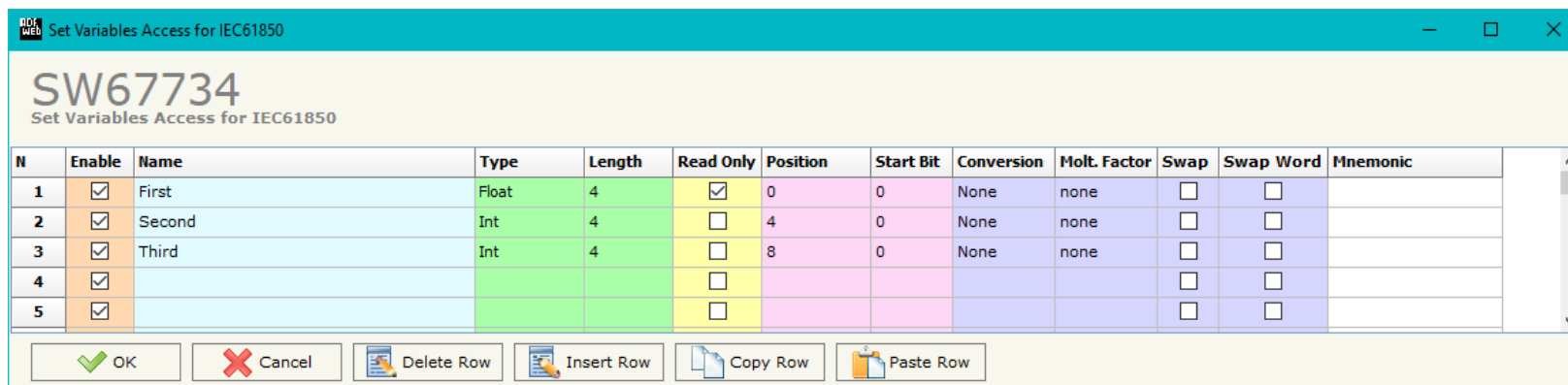

Figure 4: “IEC 61850 Access” window

The means of the fields are:

- If the field “**Enable**” is checked, the IEC 61850 variable is enabled;
- In the field “**Name**” the name of the IEC 61850 variable is defined;
- In the field “**Type**” the data format of the IEC 61850 variable is defined;
- If the field “**Read Only**” is checked, the IEC 61850 variable is just in reading. Otherwise, it is writeable too;
- In the field “**Position**” the starting byte of the internal memory arrays from/to which taking/mapping the data is defined;
- In the field “**Start Bit**” the starting bit of the byte of the field “Position” is defined;
- In the field “**Conversion**” the conversion of the data is defined. This option is used to convert the data format between Modbus and IEC 61850;
- In the field “**Molt. Factor**” a multiplicative factor of the value is defined;
- If the field “**Swap**” is checked, the bytes’ order is reversed;
- If the field “**Swap World**” is checked, the words’ order is reversed;
- In the field “**Mnemonic**” a description of the variable is defined.

**TLS KNOWN CERTIFICATE:**

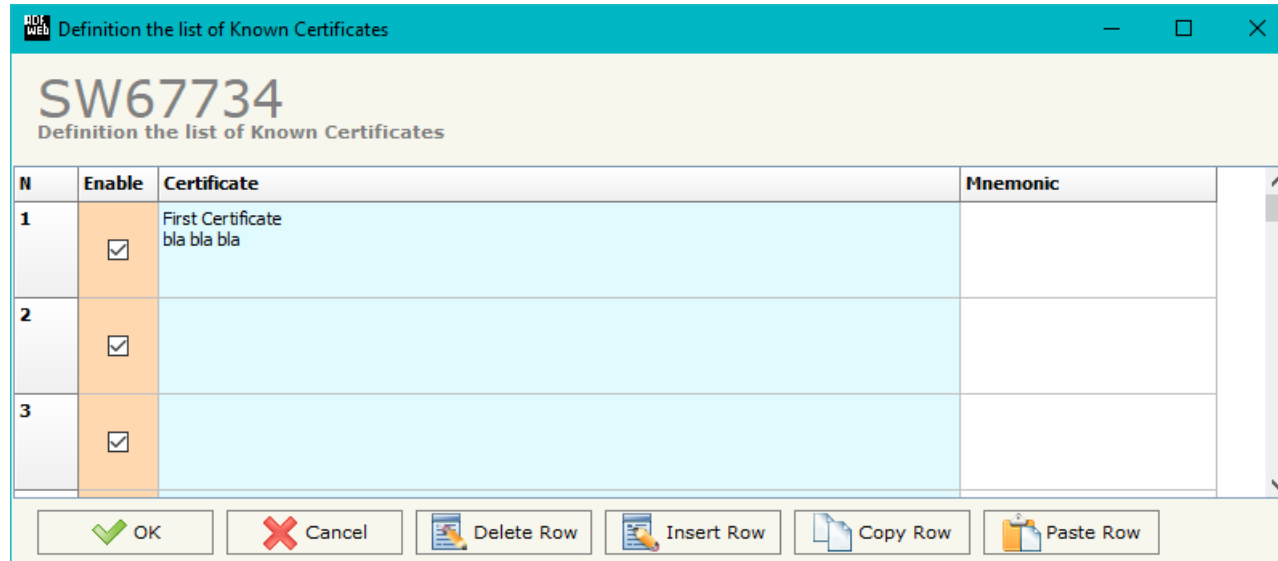

Figure 5: "TLS Known Certificate" window

By pressing the **"TLS Known Certificate"** button from the Main Window of SW67734 (Fig. 2) the "Definition the list of Known Certificates" window appears (Fig. 5).

The data of the columns have the following meanings:

- If the field **"Enable"** is checked, the TLS certificate is allowed;
- In the field **"Certificate"** the certificate of the Client is defined;
- In the field **"Mnemonic"** a description is defined.

### UPDATE DEVICE:

By pressing the **“Update Device”** button, it is possible to load the created Configuration into the device; and also the Firmware, if necessary. This by using the Ethernet port.

If you don't know the actual IP address of the device you have to use this procedure:

- Turn OFF the Device;
- Put Dip1 of 'Dip-Switch A' in ON position;
- Turn ON the device
- Connect the Ethernet cable;
- Insert the IP **“192.168.2.205”**;
- Select which operations you want to do;
- Press the **“Execute update firmware”** button to start the upload;
- When all the operations are “OK” turn OFF the Device;
- Put Dip1 of 'Dip-Switch A' in OFF position;
- Turn ON the device.

If you know the actual IP address of the device, you have to use this procedure:

- Turn ON the Device with the Ethernet cable inserted;
- Insert the actual IP of the Converter;
- Select which operations you want to do;
- Press the **“Execute update firmware”** button to start the upload;
- When all the operations are “OK” the device automatically goes at Normal Mode.

At this point the configuration/firmware on the device is correctly updated.

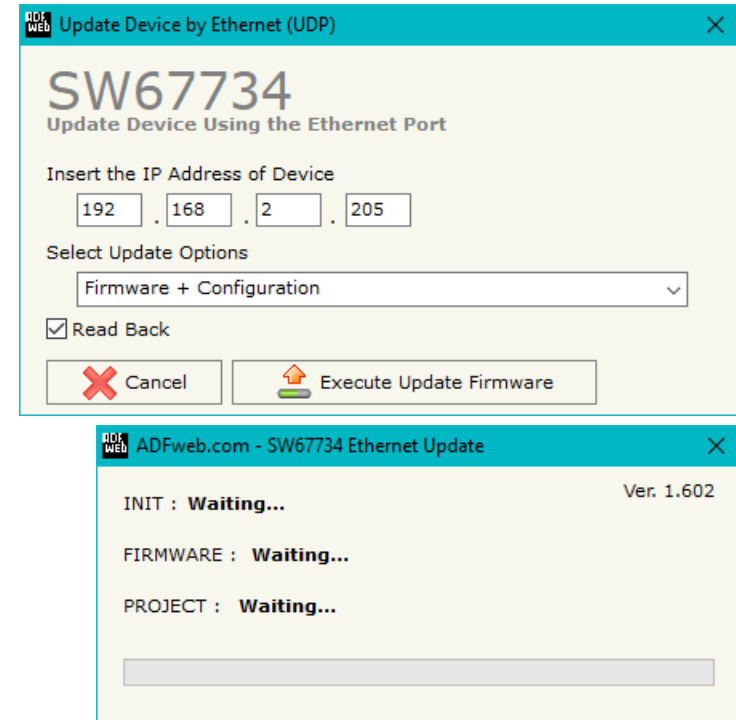

Figure 6: “Update device” windows

**Note:**

When you receive the device, for the first time, you also have to update the Firmware in the HD67734 device.

**Warning:**

If Fig. 7 appears when you try to do the Update try these points before seeking assistance:

- Try to repeat the operations for the updating;
- Try with another PC;
- Try to restart the PC;
- Check the LAN settings;
- If you are using the program inside a Virtual Machine, try to use in the main Operating System;
- If you are using Windows Seven, Vista, 8 or 10 make sure that you have the administrator privileges;
- In case you have to program more than one device, using the "UDP Update", you have to cancel the ARP table every time you connect a new device on Ethernet. For do this you have to launch the "Command Prompt" and write the command "arp -d". Pay attention that with Windows Vista, Seven, 8, 10 you have to launch the "Command Prompt" with Administrator Rights;
- Pay attention at Firewall lock.

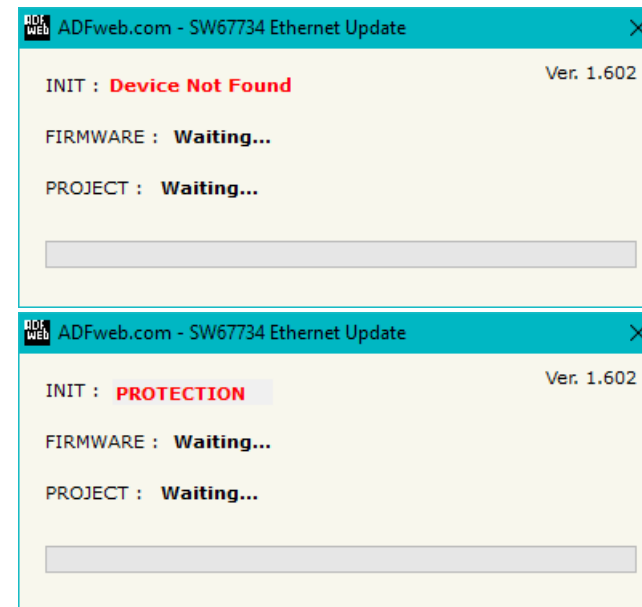

Figure 7: "Error" window

**Warning:**

In the case of HD67734 you have to use the software "SW67734": [www.adfweb.com/download/filefold/SW67734.zip](http://www.adfweb.com/download/filefold/SW67734.zip).



**MODBUS MAP:**

On Modbus side, the map is created automatically. In relation to the configuration defined, it is possible to have two different maps.

Read with Input Register / Status Function not enabled

Data in reading:

| Type             | Address | Function | Description                             |
|------------------|---------|----------|---|
| Holding Register | 0       | 03       | Input Bytes 0-1 of internal array       |
| Holding Register | 1       | 03       | Input Bytes 2-3 of internal array       |
| Holding Register | 2       | 03       | Input Bytes 4-5 of internal array       |
| .                |         |          |   |
| .                |         |          |   |
| Holding Register | 718     | 03       | Input Bytes 1436-1437 of internal array |

Data in writing:

| Type             | Address | Function | Description                              |
|------------------|---------|----------|--|
| Holding Register | 0       | 06/16    | Output Bytes 0-1 of internal array       |
| Holding Register | 1       | 06/16    | Output Bytes 2-3 of internal array       |
| Holding Register | 2       | 06/16    | Output Bytes 4-5 of internal array       |
| .                |         |          |  |
| .                |         |          |  |
| Holding Register | 718     | 06/16    | Output Bytes 1436-1437 of internal array |



Note:

The data can be read/written as single bits too using Coil Status (Function 01 and Functions 05/15).

Read with Input Register / Status Function enabled

Data in reading:

| Type           | Address | Function | Description                             |
|----------------|---------|----------|---|
| Input Register | 0       | 04       | Input Bytes 0-1 of internal array       |
| Input Register | 1       | 04       | Input Bytes 2-3 of internal array       |
| Input Register | 2       | 04       | Input Bytes 4-5 of internal array       |
| .              |         |          |   |
| .              |         |          |   |
| Input Register | 718     | 04       | Input Bytes 1436-1437 of internal array |

Data in writing:

| Type             | Address | Function          | Description                              |
|------------------|---------|-------------------|--|
| Holding Register | 0       | R: 03<br>W: 06/16 | Output Bytes 0-1 of internal array       |
| Holding Register | 1       | R: 03<br>W: 06/16 | Output Bytes 2-3 of internal array       |
| Holding Register | 2       | R: 03<br>W: 06/16 | Output Bytes 4-5 of internal array       |
| .                |         |                   |  |
| .                |         |                   |  |
| Holding Register | 718     | R: 03<br>W: 06/16 | Output Bytes 1436-1437 of internal array |



Note:

The data can be read/written as single bits too using Input/Coil Status (Function 02 and Functions 01/05/15).

**MECHANICAL DIMENSIONS:**

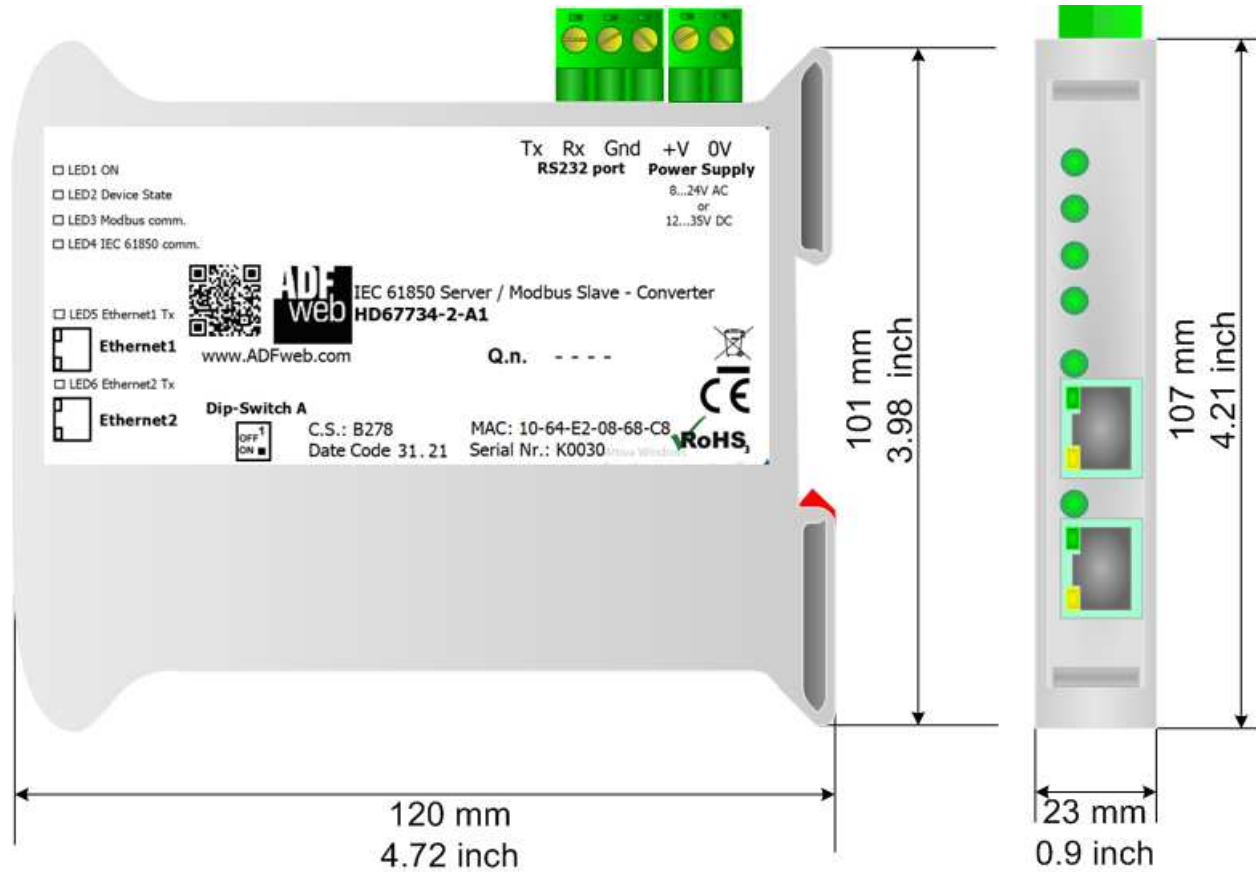

Housing: PVC  
 Weight: 200g (Approx)

Figure 8a: Mechanical dimensions scheme for HD67734-X-A1

### ORDERING INFORMATIONS:

The ordering part number is formed by a valid combination of the following:

**HD67734 - x - xx**

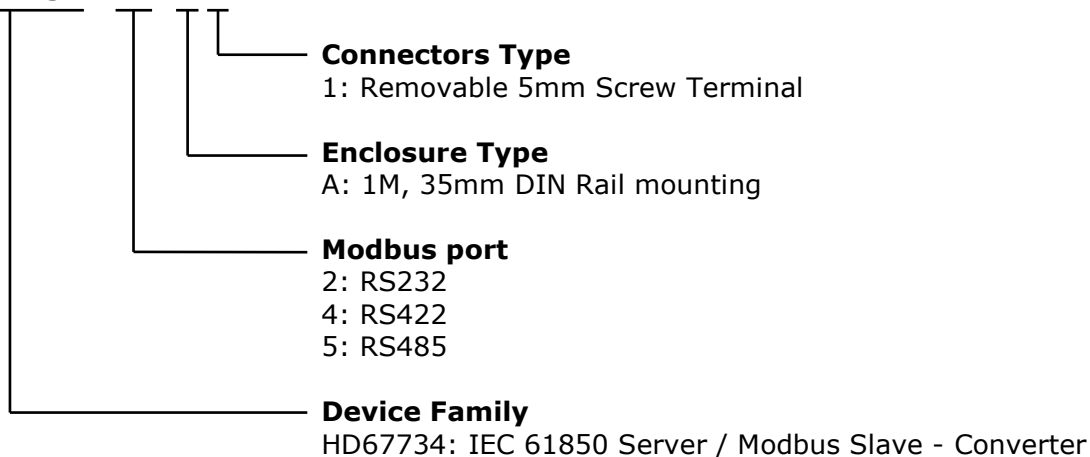

- Order Code: **HD67734-2-A1** - IEC 61850 Server / Modbus Slave - Converter (Modbus port: RS232)
- Order Code: **HD67734-4-A1** - IEC 61850 Server / Modbus Slave - Converter (Modbus port: RS422)
- Order Code: **HD67734-5-A1** - IEC 61850 Server / Modbus Slave - Converter (Modbus port: RS485)

### ACCESSORIES:

- Order Code: **AC34011** - 35mm Rail DIN - Power Supply 220/240V AC 50/60Hz – 12 V DC
- Order Code: **AC34012** - 35mm Rail DIN - Power Supply 220/240V AC 50/60Hz – 24 V DC

**DISCLAIMER:**

All technical content within this document can be modified without notice. The content of the document is a under continual renewal. For losses due to fire, earthquake, third party access or other accidents, or intentional or accidental abuse, misuse, or use under abnormal conditions repairs are charged to the user. ADFweb.com S.r.l. will not be liable for accidental loss of use or inability to use this product, such as loss of business income. ADFweb.com S.r.l. shall not be liable for consequences of improper use.

**OTHER REGULATIONS AND STANDARDS:****WEEE INFORMATION**

Disposal of old electrical and electronic equipment (as in the European Union and other European countries with separate collection systems).

— This symbol on the product or on its packaging indicates that this product may not be treated as household rubbish. Instead, it should be taken to an applicable collection point for the recycling of electrical and electronic equipment. If the product is disposed correctly, you will help prevent potential negative environmental factors and impact of human health, which could otherwise be caused by inappropriate disposal. The recycling of materials will help to conserve natural resources. For more information about recycling this product, please contact your local city office, your household waste disposal service or the shop where you purchased the product.

**RESTRICTION OF HAZARDOUS SUBSTANCES DIRECTIVE**

The device respects the 2002/95/EC Directive on the restriction of the use of certain hazardous substances in electrical and electronic equipment (commonly referred to as Restriction of Hazardous Substances Directive or RoHS).

**CE MARKING**

The product conforms with the essential requirements of the applicable EC directives.

**WARRANTIES AND TECHNICAL SUPPORT:**

For fast and easy technical support for your ADFweb.com SRL products, consult our internet support at [www.adfweb.com](http://www.adfweb.com).  
Otherwise contact us at the address [support@adfweb.com](mailto:support@adfweb.com)

**RETURN POLICY:**

If while using your product you have any problem and you wish to exchange or repair it, please do the following:

- Obtain a Product Return Number (PRN) from our internet support at [www.adfweb.com](http://www.adfweb.com). Together with the request, you need to provide detailed information about the problem.
- Send the product to the address provided with the PRN, having prepaid the shipping costs (shipment costs billed to us will not be accepted).

If the product is within the warranty of twelve months, it will be repaired or exchanged and returned within three weeks. If the product is no longer under warranty, you will receive a repair estimate.



**ADFweb.com S.r.l.**  
Via Strada Nuova, 17  
IT-31010 Mareno di Piave  
TREVISO (Italy)  
Phone +39.0438.30.91.31  
Fax +39.0438.49.20.99  
[www.adfweb.com](http://www.adfweb.com)

