

User Manual

Revision 1.000
English

Modbus Slave / Modbus TCP Master – Converter

(Order Code: HD674-A003)

For Website information:

www.adfweb.com?Product=HD674-A003

For Price information:

www.adfweb.com?Price=HD674-A003

Benefits and Main Features:

- ⊕ Very easy to configure
- ⊕ Wide supply input range
- ⊕ Electrical isolation
- ⊕ Industrial temperature range:
- ⊕ -40°C / 105°C (-40°F / 221°F)



For others Gateways / Bridges:

J1939 to Modbus

See also the following links:

www.adfweb.com?Product=HD67212 (Modbus RTU)

CANopen to Modbus

See also the following links:

www.adfweb.com?Product=HD67001 (Modbus RTU Master)

www.adfweb.com?Product=HD67002 (Modbus RTU Slave)

www.adfweb.com?Product=HD67004 (Modbus TCP Master)

www.adfweb.com?Product=HD67005 (Modbus TCP Slave)

For others Gateways / Bridges:

For **CAN bus 2.0A** and/or **CAN bus 2.0B to Modbus**

See also the following links:

www.adfweb.com?Product=HD67011 (Modbus RTU Slave)

www.adfweb.com?Product=HD67012 (Modbus RTU Master)

www.adfweb.com?Product=HD67014 (Modbus TCP Slave)

www.adfweb.com?Product=HD67015 (Modbus TCP Master)

Do you have an your customer protocol?

See the following links:

www.adfweb.com?Product=HD67003

Do you need to choose a device? do you want help?

Ask it to the following link:

www.adfweb.com?Cmd=helpme



User Manual

INDEX:

	Page
INDEX	2
UPDATED DOCUMENTATION	2
REVISION LIST	2
WARNING	2
TRADEMARKS	2
SECURITY ALERT	3
EXAMPLES OF CONNECTION	4
CONNECTION SCHEME	5
CHARACTERISTICS	7
CONFIGURATION	7
POWER SUPPLY	8
LEDS	9
RS485	10
ETHERNET	11
USB	11
USE OF COMPOSITOR SW674-A003	12
NEW PROJECT / OPEN PROJECT	13
SOFTWARE OPTIONS	14
SET COMMUNICATION	15
TRANSLATE TABLE	17
UPDATE DEVICE	22
MECHANICAL DIMENSIONS	24
ORDER CODE	28
ACCESSORIES	28
DISCLAIMER	29
OTHER REGULATIONS AND STANDARDS	29
WARRANTIES AND TECHNICAL SUPPORT	30
RETURN POLICY	30

UPDATED DOCUMENTATION:

Dear customer, we thank you for your attention and we remind you that you need to check that the following document is:

- Updated
- Related to the product you own

To obtain the most recently updated document, note the “document code” that appears at the top right-hand corner of each page of this document.

With this “Document Code” go to web page www.adfweb.com/download/ and search for the corresponding code on the page. Click on the proper “Document Code” and download the updates.

REVISION LIST:

Revision	Date	Author	Chapter	Description
1.000	11/01/2017	Ff	All	First released version

WARNING:

ADFweb.com reserves the right to change information in this manual about our product without warning.
ADFweb.com is not responsible for any error this manual may contain.

TRADEMARKS:

All trademarks mentioned in this document belong to their respective owners.

SECURITY ALERT:**GENERAL INFORMATION**

To ensure safe operation, the device must be operated according to the instructions in the manual. When using the device, legal and safety regulation are required for each individual application. The same applies also when using accessories.

INTENDED USE

Machines and systems must be designed so the faulty conditions do not lead to a dangerous situation for the operator (i.e. independent limit switches, mechanical interlocks, etc.).

QUALIFIED PERSONNEL

The device can be used only by qualified personnel, strictly in accordance with the specifications. Qualified personnel are persons who are familiar with the installation, assembly, commissioning and operation of this equipment and who have appropriate qualifications for their job.

RESIDUAL RISKS

The device is state-of-the-art and is safe. The instruments can represent a potential hazard if they are inappropriately installed and operated by untrained personnel. These instructions refer to residual risks with the following symbol:



This symbol indicates that non-observance of the safety instructions is a danger for people that could lead to serious injury or death and / or the possibility of damage.

CE CONFORMITY

The declaration is made by our company. You can send an email to support@adfweb.com or give us a call if you need it.

EXAMPLE OF CONNECTION:

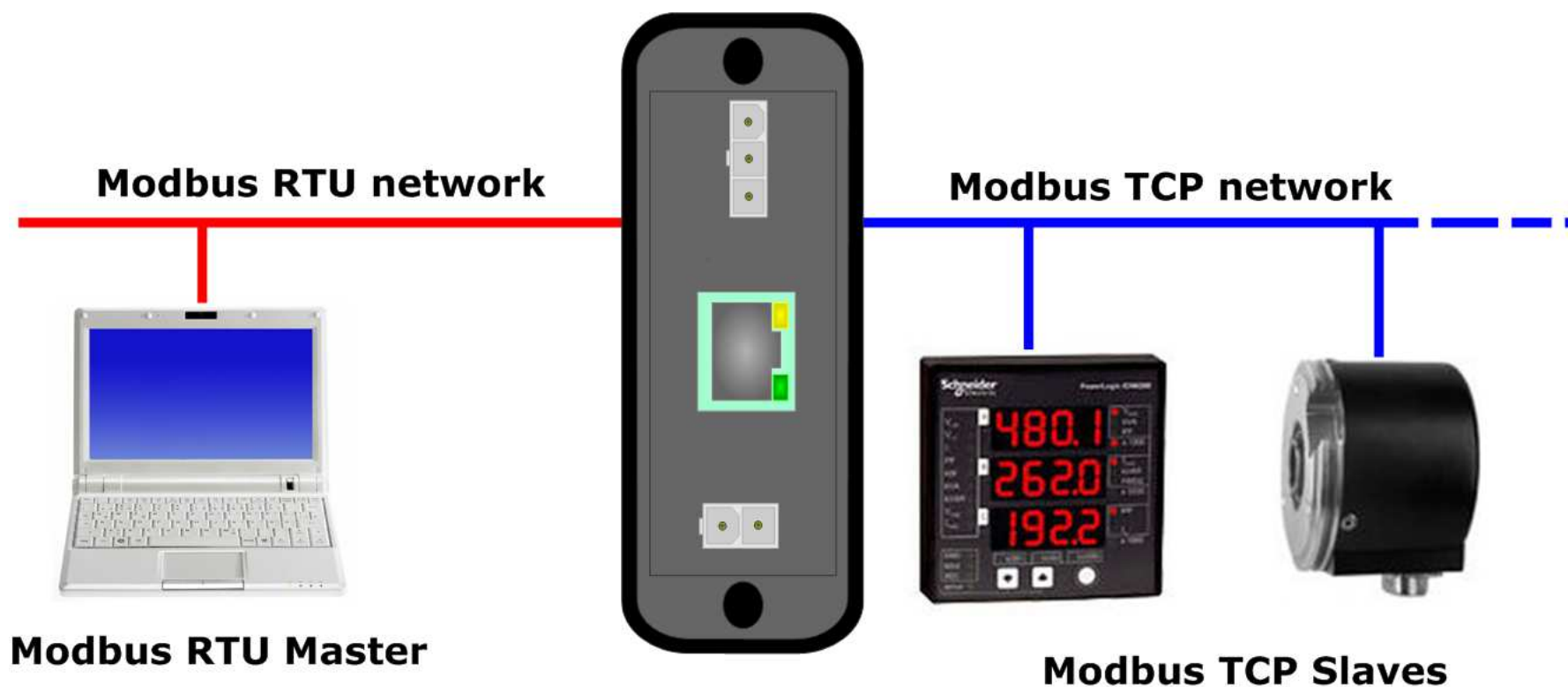

CONNECTION SCHEME:



Figure 1a: Connection scheme for HD674-A003-E4x-xx

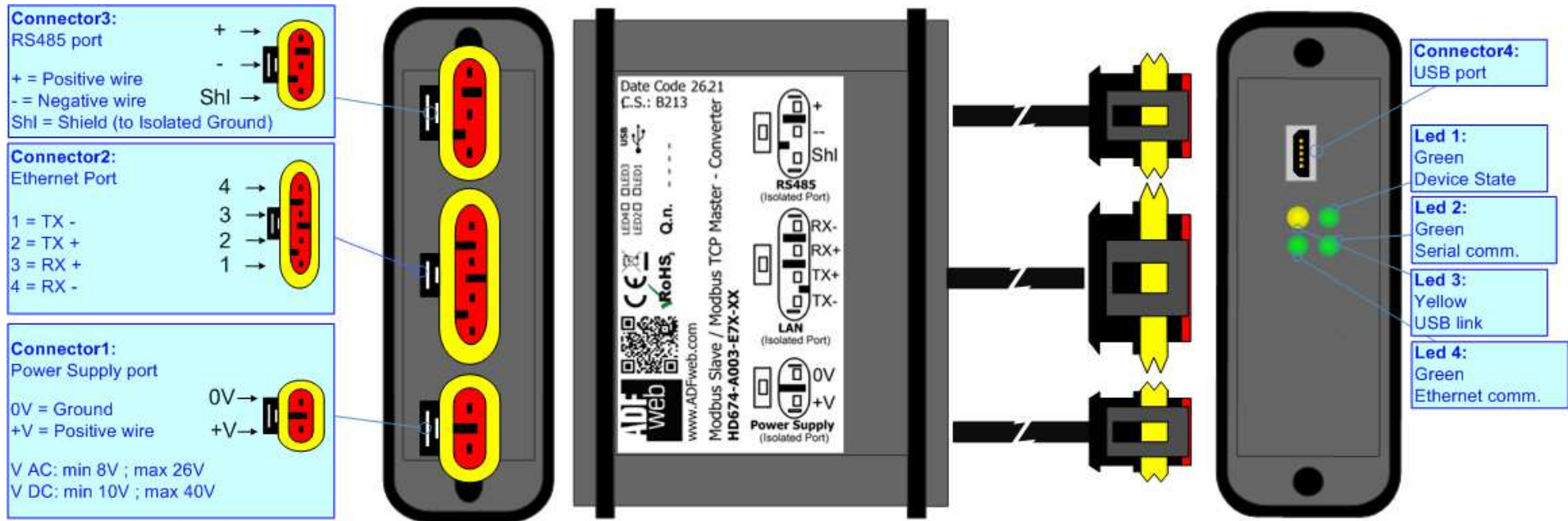

Figure 1b: Connection scheme for HD674-A003-E7x-xx

CHARACTERISTICS:

The "**HD674-A003**" series are rugged devices used to interface Modbus Master devices with Modbus TCP Slave network.

With its particular enclosure, equipped with four fixing lugs, makes available the mounting of the device in any plane surface (horizontal, vertical, oblique).

It is possible to have the device varnished or totally resined and also in both cases with "Mini-Fit®" connectors or "AMP SuperSeal 1.5" connectors. If is resined, the enclosure, like the "AMP SuperSeal 1.5" connectors, is waterproof.

All the four series have these characteristics:

- Triple 4kV isolation between Power Supply / Modbus / Modbus TCP;
- Varnished / Resined (optionally);
- Wide power supply input range: 8...26V AC | 10...40V DC;
- Mini-Fit® / AMP SuperSeal 1.5 connectors;
- Metal enclosure with fixing lugs;
- Possibility to use Metal hose clamps for fixing it without using lugs;
- Microprocessor for data control;
- Wide temperature range: -40°C / 105°C (-40°F / 221°F).

CONFIGURATION:

You need Compositor SW674-A003 software on your PC in order to perform the following:

- Define the parameter of Modbus line;
- Define the parameter of Modbus TCP line;
- Update the device.

POWER SUPPLY:

The devices can be powered between a wide range of tensions. For more details see the two tables below.

	VAC		VDC	
	Vmin	Vmax	Vmin	Vmax
HD674-A003-Exx-xx	8V	26V	10V	40V

Consumption at 24V DC:

Device	W/VA
HD674-A003-Exx-xx	4



Caution: Not reverse the polarity power

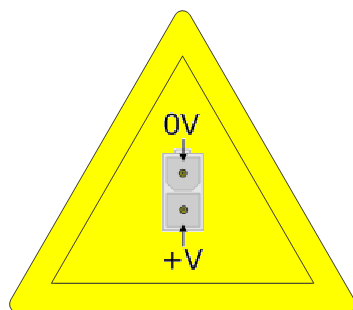

HD674-A003-E4x-xx

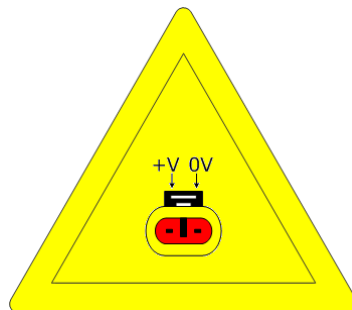

HD674-A003-E7x-xx



Note: It is possible to use also negative tensions. In this case the polarity must be inverted.

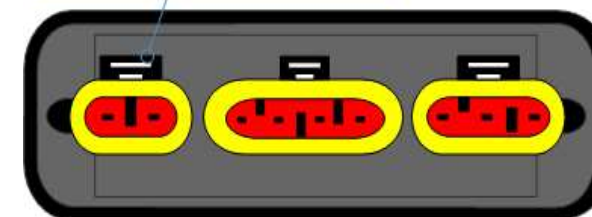
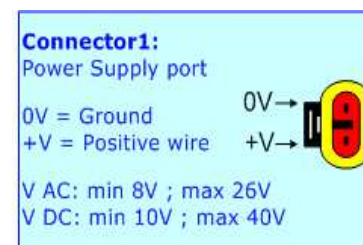

LEDS:

The device has got four LEDs that are used to give information of the functioning status. The various meanings of the LEDs are described in the table below.

LED	Normal Mode	Boot Mode
1: Device state (green)	Blinks slowly (~1Hz)	Blinks quickly: Boot state Blinks very slowly (~0.5Hz): update in progress
2: Serial Communication (green)	Blinks when Modbus messages are received	Blinks quickly: Boot state Blinks very slowly (~0.5Hz): update in progress
3: USB Link (yellow)	ON: USB cable inserted OFF: USB cable not inserted	ON: USB cable inserted OFF: USB cable not inserted
4: Ethernet communication (green)	Blinks when Modbus TCP communication is working	Blinks quickly: Boot state Blinks very slowly (~0.5Hz): update in progress

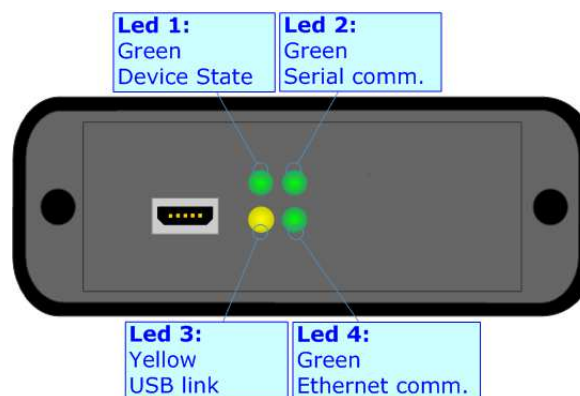

RS485:

The connection of the RS485 in the HD674-A003-E4x-xx device must be made with a 3way MiniFit Female connector. The pinout of Male MiniFit connector of the board is at right side of the page.

The connection of the RS485 in the HD67-A003-E7x-xx device must be made with a AMP SuperSeal 1.5 Male connector. The pinout of Female connector of the board is at right side of the page.

The termination of RS485 line, with a 120Ω resistor, in the HD674-A003-Exx-xx is made internally of the device; when the order is performed. If the device have the RS485 terminated the code is the follow: HD674-A003-Exx-Yx; otherwise is this other: HD674-A003-Exx-Nx.

The maximum length of the cable should be 1200m (4000 feet).

Here some codes of cables:

- Belden: p/n 8132 - 2x 28AWG stranded twisted pairs conductor + foil shield + braid shield;
- Belden p/n 82842 - 2x 24AWG stranded twisted pairs conductor + foil shield + braid shield;
- Tasker: p/n C521 - 1x 24AWG twisted pair conductor + foil shield + braid shield;
- Tasker: p/n C522 - 2x 24AWG twisted pairs conductor + foil shield + braid shield.

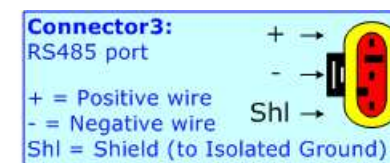

Link for Mini-Fit® connectors: http://www.molex.com/molex/products/group?key=minifit_products&channel=products

Link for SuperSeal 1.5 connectors: <http://www.te.com/catalog/cinf/en/c/10876/956>

ETHERNET:

The connection of Ethernet in the HD674-A003 device must be made with at least a Category 5E cable. The maximum length of the cable should not exceed 100m. The cable has to conform to the T568 norms relative to connections in cat.5 up to 100 Mbps. To connect the device to an Hub/Switch is recommended the use of a straight cable, to connect the device to a PC/PLC/other is recommended the use of a cross cable.

The connection of Ethernet in the HD674-A003-E4x-xx device must be made with RJ45 connector.

The connection of the Ethernet in the HD674-A003-E7x-xx device must be made with a AMP SuperSeal 1.5 Male connector. The pinout of Female connector of the board is at right side of the page.

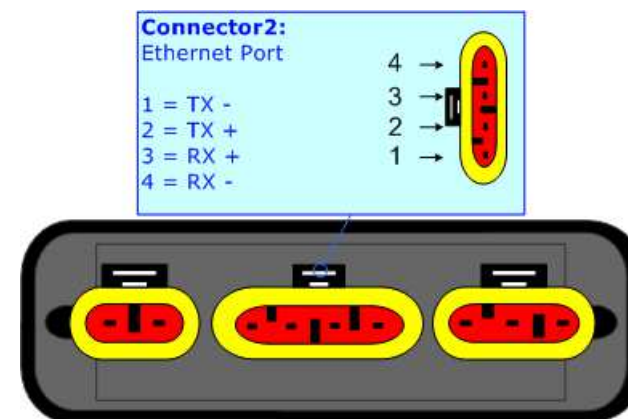

USB:

The USB port is used to start the converter in Boot Mode. It is necessary to use a Micro USB type B cable.

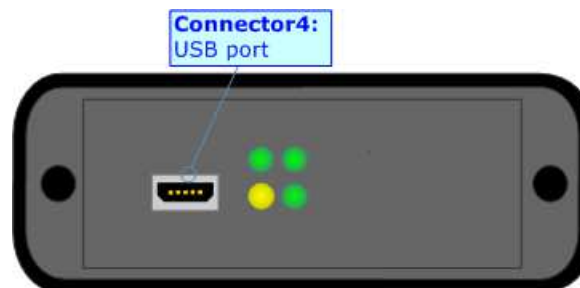

USE OF COMPOSITOR SW674-A003:

To configure the Converter, use the available software that runs with Windows called SW674-A003. It is downloadable on the site www.adfweb.com and its operation is described in this document. (*This manual is referenced to the last version of the software present on our web site*). The software works with MSWindows (XP, Vista, Seven, 8, 10; 32/64bit).

When launching the SW674-A003, the window below appears (Fig. 2).

**Note:**

It is necessary to have installed .Net Framework 4.

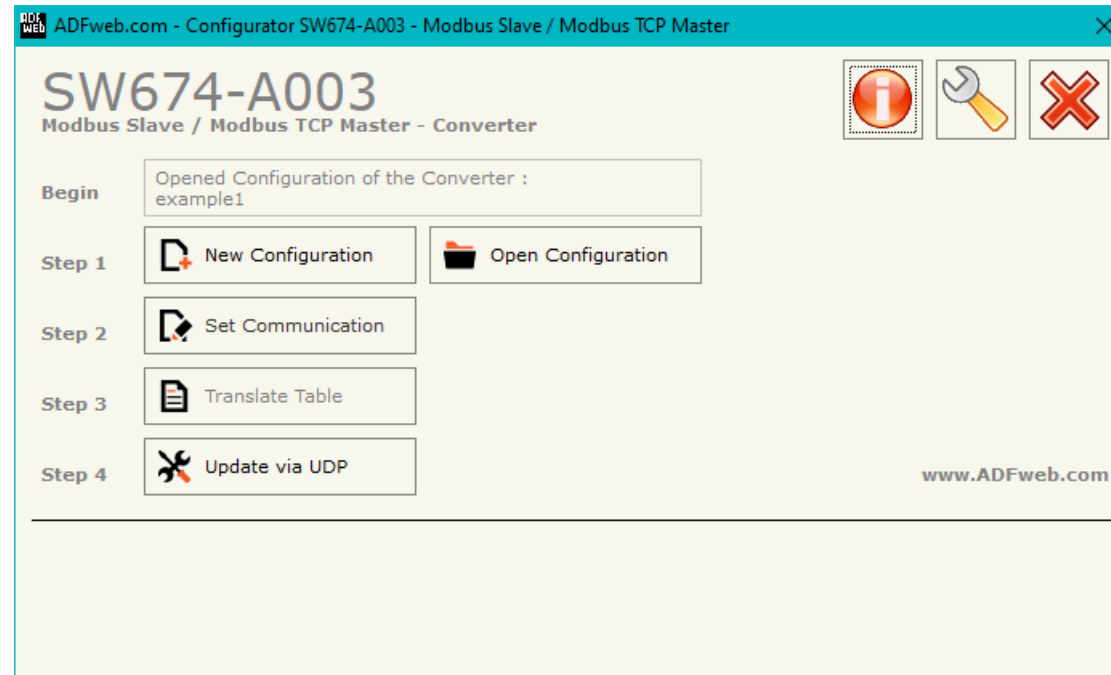
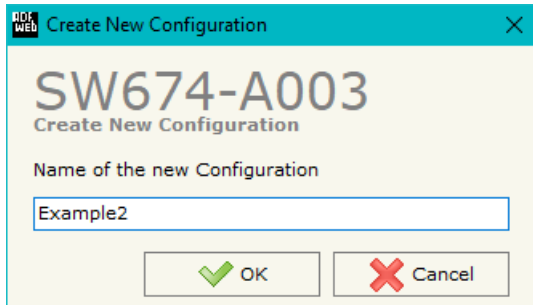

Figure 2: Main window for SW674-A003

NEW CONFIGURATION / OPEN CONFIGURATION:

The “**New Configuration**” button creates the folder which contains the entire device’s configuration.



A device’s configuration can also be imported or exported:

- To clone the configurations of a programmable “ Modbus Slave / Modbus TCP Master - Converter” in order to configure another device in the same manner, it is necessary to maintain the folder and all its contents;
- To clone a project in order to obtain a different version of the project, it is sufficient to duplicate the project folder with another name and open the new folder with the button “**Open Configuration**”.

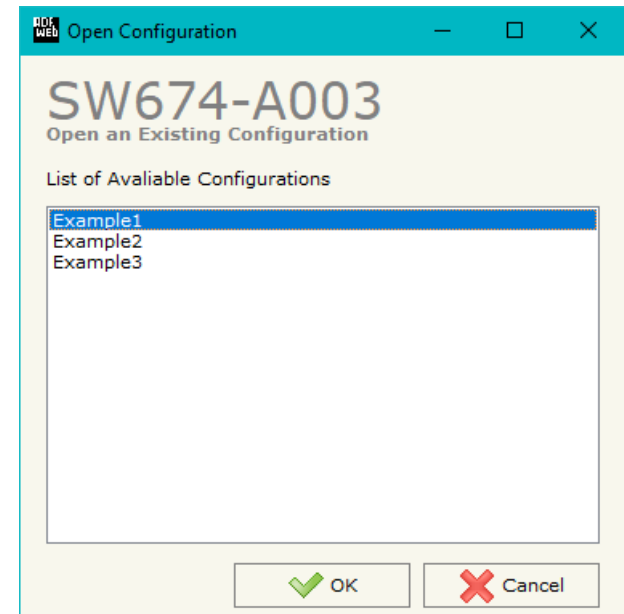

SOFTWARE OPTIONS:

By pressing the “**Settings**” () button there is the possibility to change the language of the software and check the updatings for the compositor.

In the section “Language” it is possible to change the language of the software.

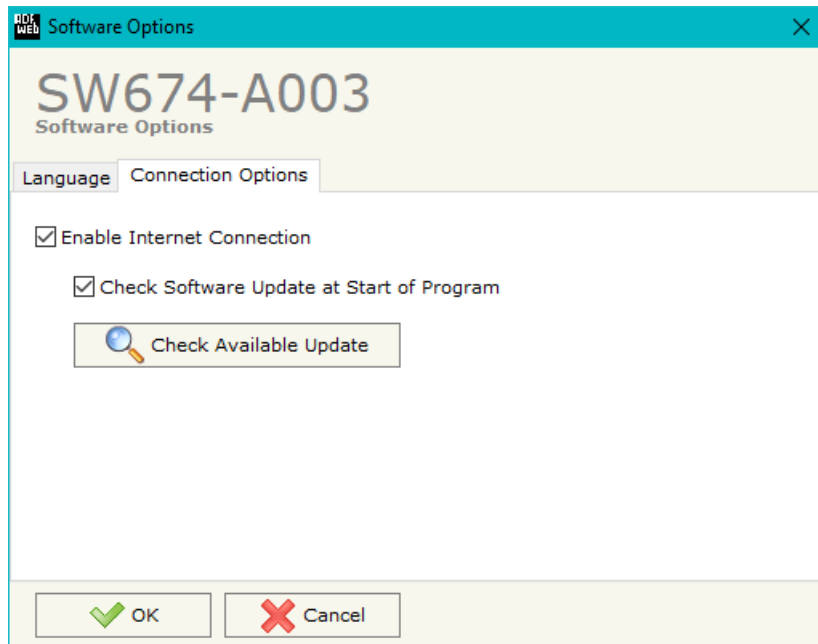

In the section “Connection Options”, it is possible to check if there are some updatings of the software compositor in ADFweb.com website. Checking the option “**Check Software Update at Start of Program**”, the SW674-A003 checks automatically if there are updatings when it is launched.

SET COMMUNICATION:

This section define the fundamental communication parameters of two buses, Modbus TCP Slave and Modbus Master.

By Pressing the **"Set Communication"** button from the main window of SW674-A003 (Fig. 2) the window "Set Communication" appears (Fig. 3).

The meaning of the fields of "Operation Mode" are:

- In the field **"Operation Mode"** the operating mode of the converter is defined:
 - **Normal Mode (with Translate Table):** the converter can be seen like a single serial Modbus slave. The address of Modbus is assigned in the "Set Communication" section.
 - **Routing Slave Address:** the converter can be seen like more than one serial Modbus slave. Each serial Modbus slave is a row of the table and it is possible to assign to which TCP device is linked.
 - **Work with Fix IP Address:** the converter can be seen like a single serial Modbus slave. The address of Modbus is assigned in the "Set Communication" section. It is not necessary to compile the Translate Table: every request that arrives on serial is transferred on TCP (using TCP format of frame) to the slave with the IP address defined in the "Set Communication" section.

The means of the fields for the "Modbus Slave" section are:

- In the field **"Serial"** the serial lien to use for Modbus communication is defined;
- In the field **"Baudrate"** the baudrate for the serial line is defined;
- In the field **"Parity"** the parity of the serial line is defined;
- In the field **"Stop Bits"** the number of Stop Bits is defined;
- In the field **"ID Device"** the address of serial Modbus device is defined. This field can be compiled only if the selected "Operation Mode" is "Normal Mode (with Translate Table)" or "Work with Fix IP Address";
- If the option **"No Modbus Exception on TCP TimeOut"** is checked, the converter does not send any exception code in case of missing response from Modbus TCP side. Otherwise, it sends the exception code 0x36.

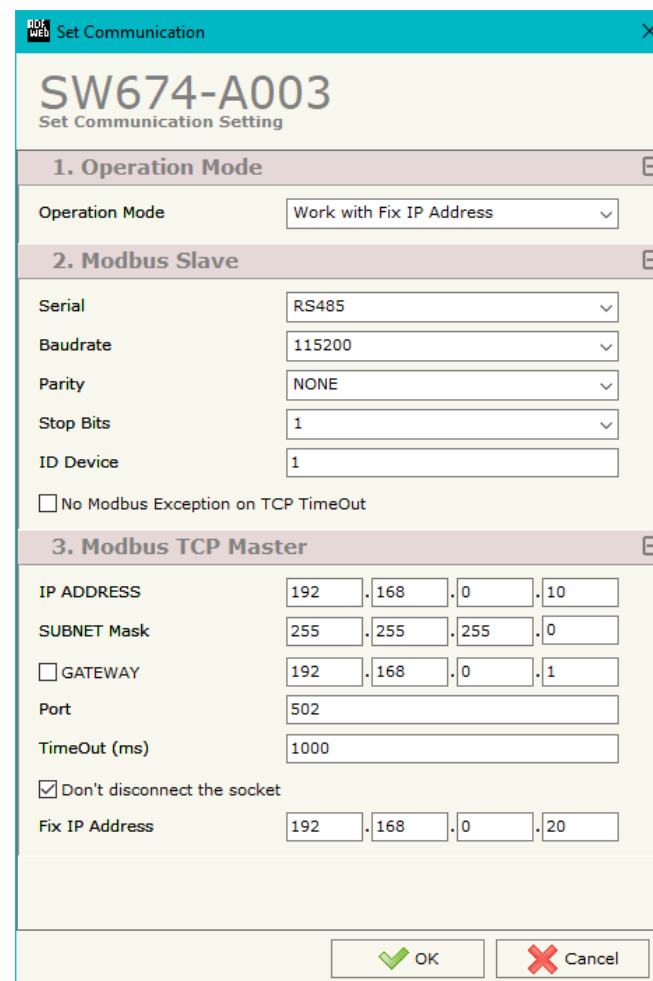

Figure 3: "Set Communication" window

The means of the fields for the "Modbus TCP Master" section are:

- ➔ In the field "**IP Address**" the IP address of the converter is defined;
- ➔ In the field "**SubNet Mask**" the Subnet Mask of the converter is defined;
- ➔ In the field "**Gateway**" the default gateway of the net is defined. This feature can be enabled or disabled pressing the Check Box field. This feature is used for going out of the net;
- ➔ In the field "**Port**" the TCP port for Modbus TCP communication of the converter is defined;
- ➔ In the field "**TimeOut (ms)**" the maximum time that the converter attends for the answer from the Slave interrogated is defined;
- ➔ If the option "**Don't disconnect the socket**" is checked, the converter will hold the TCP connection opened. Otherwise. It will close it after every request/response.
- ➔ In the field "**Fix IP Address**" the IP Address of the Modbus TCP slave is defined (only if "Work with Fix IP Address" mode is set).

NORMAL MODE (WITH TRANSLATE TABLE):

Using this function, the converter can be seen like a single serial Modbus slave. The address of Modbus is assigned in the "Set Communication" section.

By pressing the "Translate Table" button from the main window for SW674-A003 (Fig. 2), the window "Set Translate Table" appears (Fig. 4).

The data of the columns have the following meanings:

- In the field "Data Type" the type of Modbus data is defined;
- In the field "Address" the address of the Modbus register to which address the requests on RTU side is defined;
- In the field "IP Address TCP" the IP address of the Modbus TCP slave to which the converter will address the request is defined;
- In the field "Address TCP" the address of the Modbus register to which the converter will address the TCP request is defined;
- In the field "NPoint" the number of consecutive registers starting from the one set is defined;
- In the field "Mnemonic" a brief description is defined.

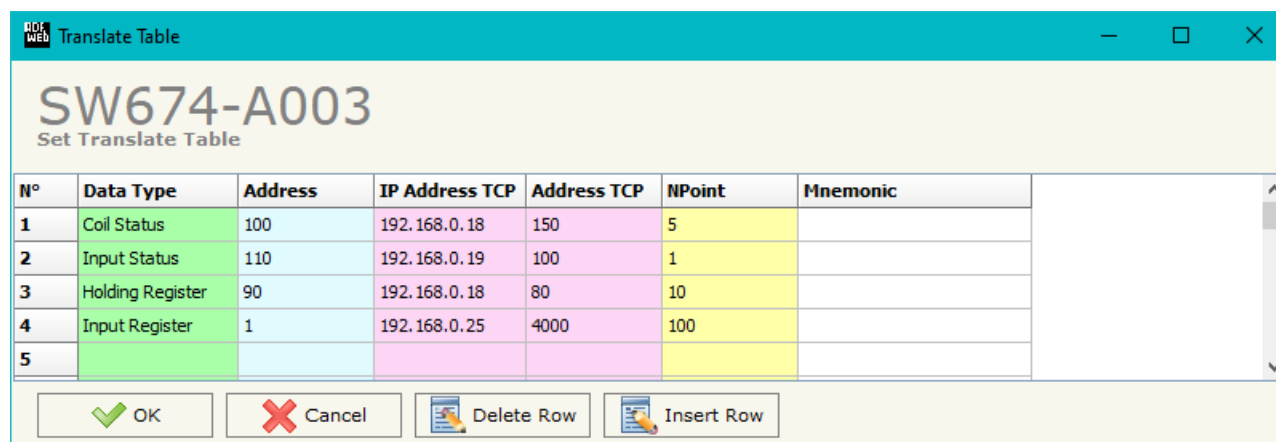

Figure 4: "Set Translate Table" window

EXAMPLE 1:

Taking the first row of Figure 4:

- Step 1:** A serial Modbus master do the request to the Converter to read the "Coil Status" address 100 for 5 consecutive points;
- Step 2:** The Converter sends to the TCP Slave 192.168.0.18 the read request of "Coil Status" address 150 for 5 consecutive points;
- Step 3:** The slave TCP replies to the Converter with the data;
- Step 4:** The Converter sends back the data on serial.

EXAMPLE 2:

Taking the second row of Figure 4:

- Step 1:** A serial Modbus master do the request to the Converter to read the "Input Status" address 110;
- Step 2:** The Converter sends to the TCP Slave 192.168.0.19 the read request of "Input Status" address 100;
- Step 3:** The slave TCP replies to the Converter with the data;
- Step 4:** The Converter sends back the data on serial.

EXAMPLE 3:

Taking the third row of Figure 4:

- Step 1:** A serial Modbus master do the request to the Converter to read the "Holding Register" address 91 for 6 consecutive points;
- Step 2:** The Converter sends to the TCP Slave 192.168.0.18 the read request of "Holding Register" address 81 for 6 consecutive points;
- Step 3:** The slave TCP replies to the Converter with the data;
- Step 4:** The Converter sends back the data on serial.

Note:

If the TCP slave responds with an exception, that exception code will be transmitted to the serial master. If the TCP slave does not respond within the estimated time defined by the Timeout parameter, an exception response will be given: error code \$36.

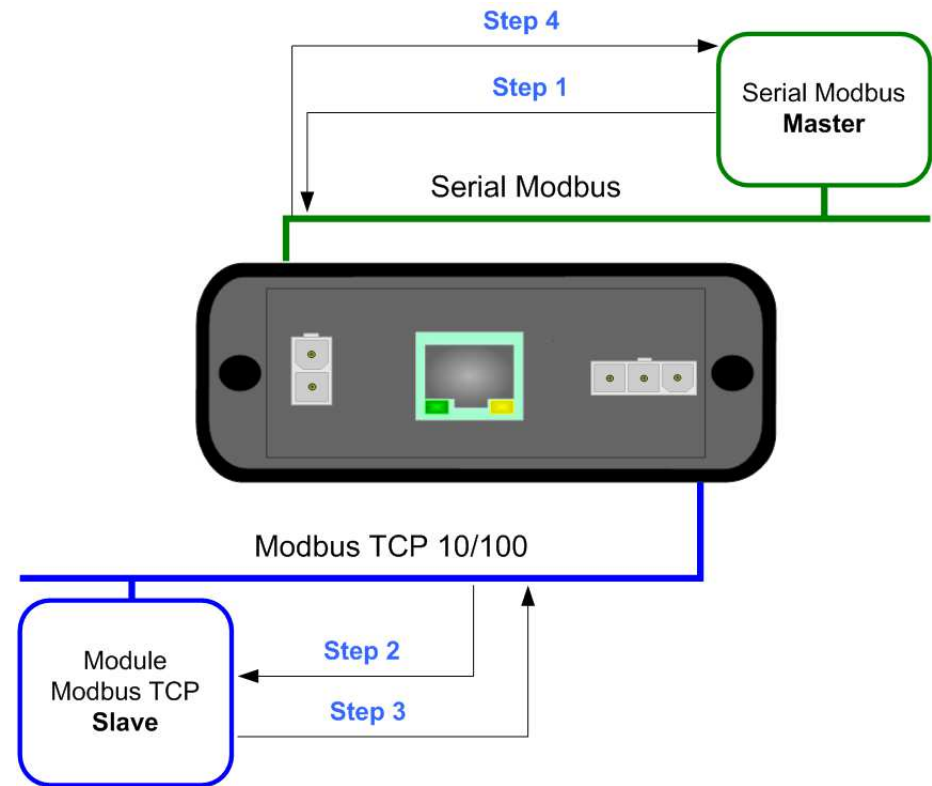

Figure 5: Chart of Request data from serial Modbus

ROUTING SLAVE ADDRESS:

Using this function, the converter can be seen like more than one serial Modbus slave. Each serial Modbus slave is a row of the table and it is possible to define to which TCP device is linked.

By pressing the **Translate Table** button from the main window for SW674-A003 (Fig. 2) the window "Set Translate Table" appears (Fig. 6).

The data of the columns have the following meanings:

- In the field **Slave ID** the ID of the virtual Modbus slave device created by the converter is defined;
- In the field **IP Address TCP** the IP address of the Modbus TCP slave device to which address the TCP requests is defined;
- In the field **Slave ID TCP** the station ID of the Modbus TCP slave device to which address the TCP requests is defined;
- If the field **Reserved Socket** is checked, the converter will reserve a socket for the specific Modbus TCP slave. This socket will be closed only after the number of consecutive errors defined in the **Errors Sock** column. It is possible to reserve up to 3 sockets for 3 different Modbus TCP slaves (function available only for Hardware Version with Dip-Switches);
- If the option **UDP** is checked, Modbus over UDP communication is enabled;
- If the option **Broadcast** is checked, the broadcast requests for that slave are accepted;
- In the field **Mnemonic** a brief description is defined.

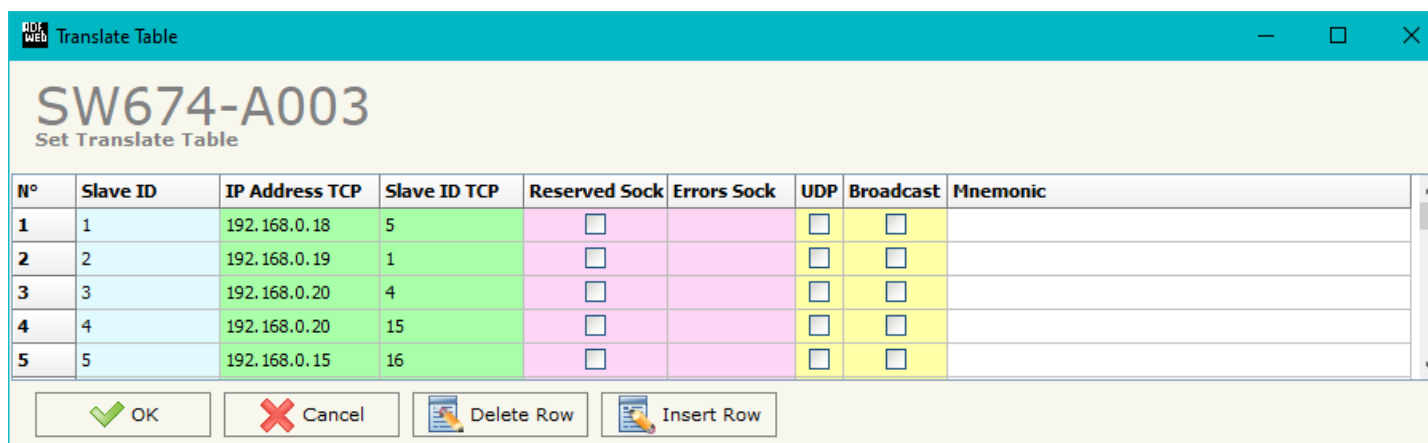

Figure 6: "Set Translate Table" window

EXAMPLE 1:

Taking the first row of Figure 6:

Step 1: A serial Modbus master do the request to the Converter to read/write a register from the serial slave Modbus ID 1;

Step 2: The Converter sends to the TCP slave 192.168.0.18 the read/write request using the TCP slave ID 5;

Step 3: The slave TCP replies to the Converter with the data;

Step 4: The Converter sends back the data on serial.

EXAMPLE 2:

Taking the second row of Figure 4:

Step 1: A serial Modbus master do the request to the Converter to read/write a register from the serial slave Modbus ID 2;

Step 2: The Converter sends to the TCP slave 192.168.0.19 the read/write request using the TCP slave ID 1;

Step 3: The slave TCP replies to the Converter with the data;

Step 4: The Converter sends back the data on serial.

EXAMPLE 3:

Taking the third row of Figure 4:

Step 1: A serial Modbus master do the request to the Converter to read/write a register from the serial slave Modbus ID 4;

Step 2: The Converter sends to the TCP slave 192.168.0.20 the read/write request using the TCP slave ID 4;

Step 3: The slave TCP replies to the Converter with the data;

Step 4: The Converter sends back the data on serial.

Note:

If the TCP slave responds with an exception, that exception code will be transmitted to the serial master. If the TCP slave does not respond within the estimated time defined by the Timeout parameter, an exception response will be given: error code \$36.

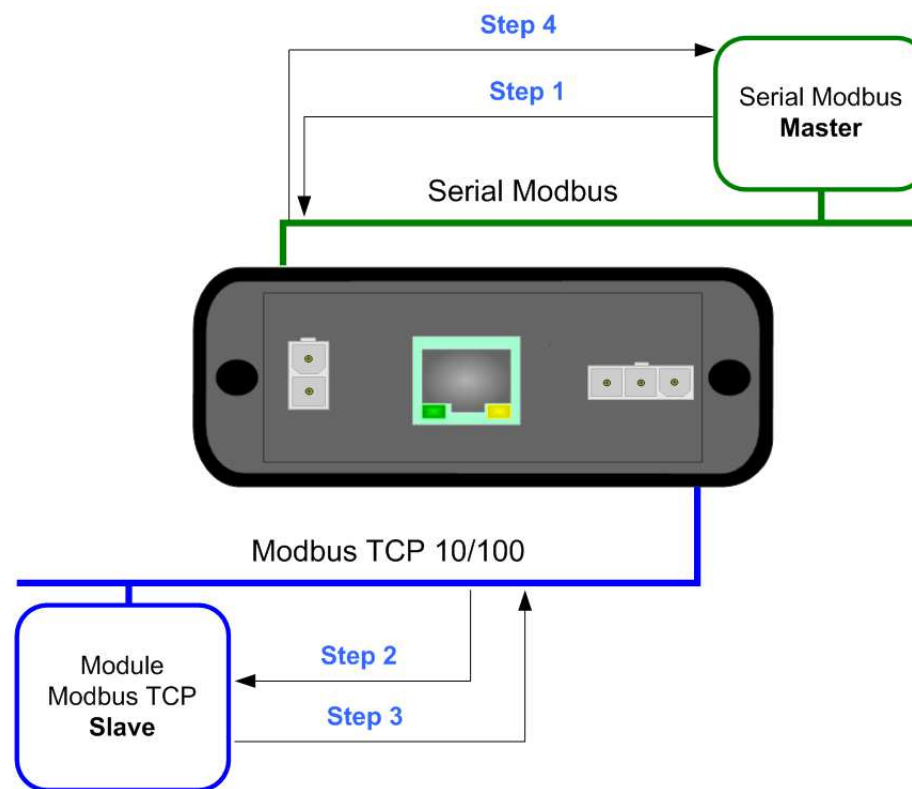

Figure 7: Chart of Request data from serial Modbus

WORK WITH FIX IP ADDRESS:

Using this function, the converter can be seen like a single serial Modbus slave. The address of Modbus is assigned in the "Set Communication" section.

In this working mode it is not necessary to compile a Translate Table; every request that arrives on serial is transferred on TCP (using TCP format of frame) to the slave with the IP address defined in the "Set Communication" section.

EXAMPLE 1:

Using the configuration of Figure 3:

Step 1: A serial Modbus master do the request to the Converter to read/write a register from the RTU Slave Address 1;

Step 2: The Converter sends to the TCP slave 192.168.0.20 the read/write request;

Step 3: The slave TCP replies to the Converter with the data;

Step 4: The Converter sends back the data on serial.

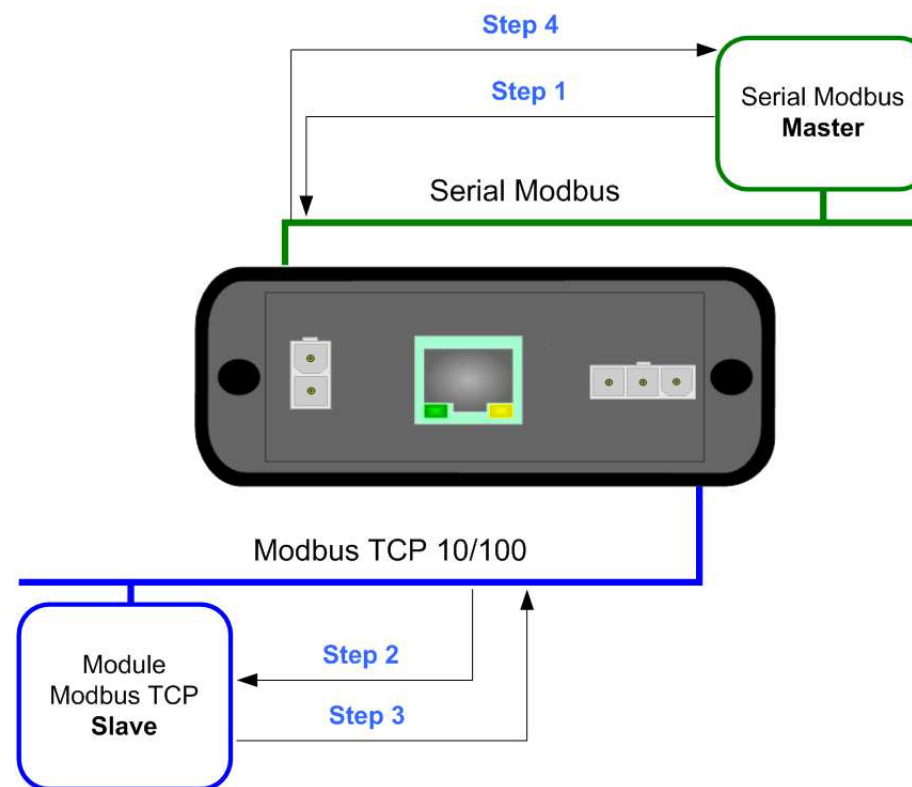

Figure 8: Chart of Request data from serial Modbus

Note: If the TCP slave responds with an exception, that exception code will be transmitted to the serial master. If the TCP slave does not respond within the estimated time defined by the Timeout parameter, an exception response will be given: error code \$36.

UPDATE DEVICE:

By pressing the **“Update Device”** button, it is possible to load the created Configuration into the device; and also the Firmware, if necessary.

If you don't know the actual IP address of the device you have to use this procedure:

- Connect the USB cable;
- Connect the Ethernet cable;
- Turn ON the converter;
- Insert the IP **“192.168.2.205”**;
- Press the **“Ping”** button, **“Device Found! must appear”**;
- Press the **“Next”** button;
- Select which operations you want to do;
- Press the **“Execute update firmware”** button to start the upload;
- When all the operations are **“OK”**, the updating is done;
- Remove the USB cable.

At this point the configuration/firmware on the device is correctly updated.

If you know the actual IP address of the device, you have to use this procedure:

- Turn on the Device with the Ethernet cable inserted;
- Insert the actual IP of the Converter;
- Press the **“Ping”** button, must appear **“Device Found!”**;
- Press the **“Next”** button;
- Select which operations you want to do;
- Press the **“Execute update firmware”** button to start the upload;
- When all the operations are **“OK”** the device automatically goes at Normal Mode

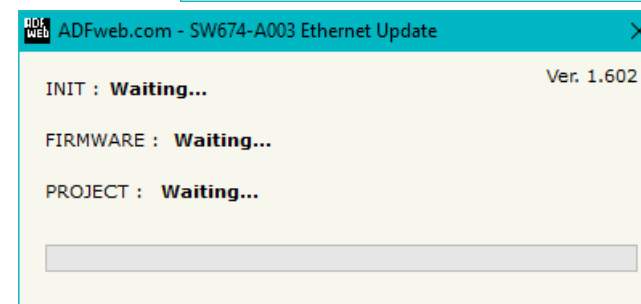
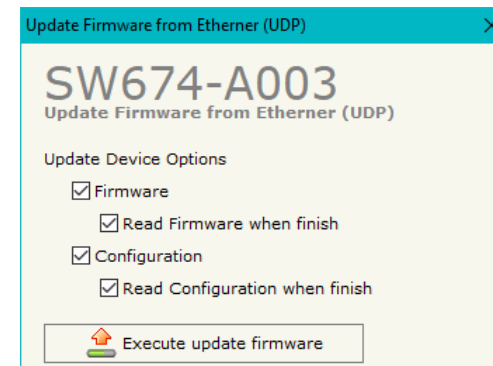
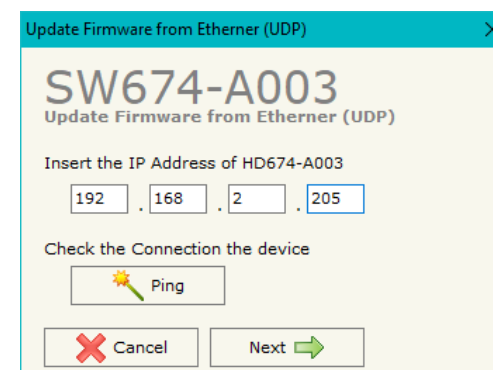

Figure 9: “Update Device” windows

**Note:**

When you install a new version of the software, if it is the first time it is better you do the update of the Firmware in the HD674-A003 device.

**Note:**

When you receive the device, for the first time, you also have to update the Firmware in the HD674-A003 device.

**Warning:**

If Fig. 6 appears when you try to do the Update try these points before seeking assistance:

- ➔ Try to repeat the operations for the updating;
- ➔ Try with another PC;
- ➔ Try to restart the PC;
- ➔ Check the LAN settings;
- ➔ If you are using the program inside a Virtual Machine, try to use in the main Operating System;
- ➔ If you are using Windows Seven, Vista, 8 or 10 make sure that you have the administrator privileges;
- ➔ In case you have to program more than one device, using the "UDP Update", you have to cancel the ARP table every time you connect a new device on Ethernet. For do this you have to launch the "Command Prompt" and write the command "arp -d". Pay attention that with Windows Vista, Seven, 8, 10 you have to launch the "Command Prompt" with Administrator Rights;
- ➔ Pay attention at Firewall lock.

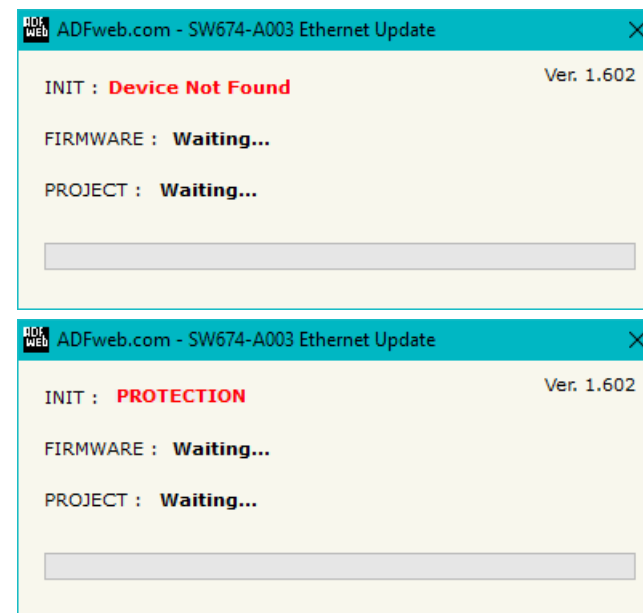
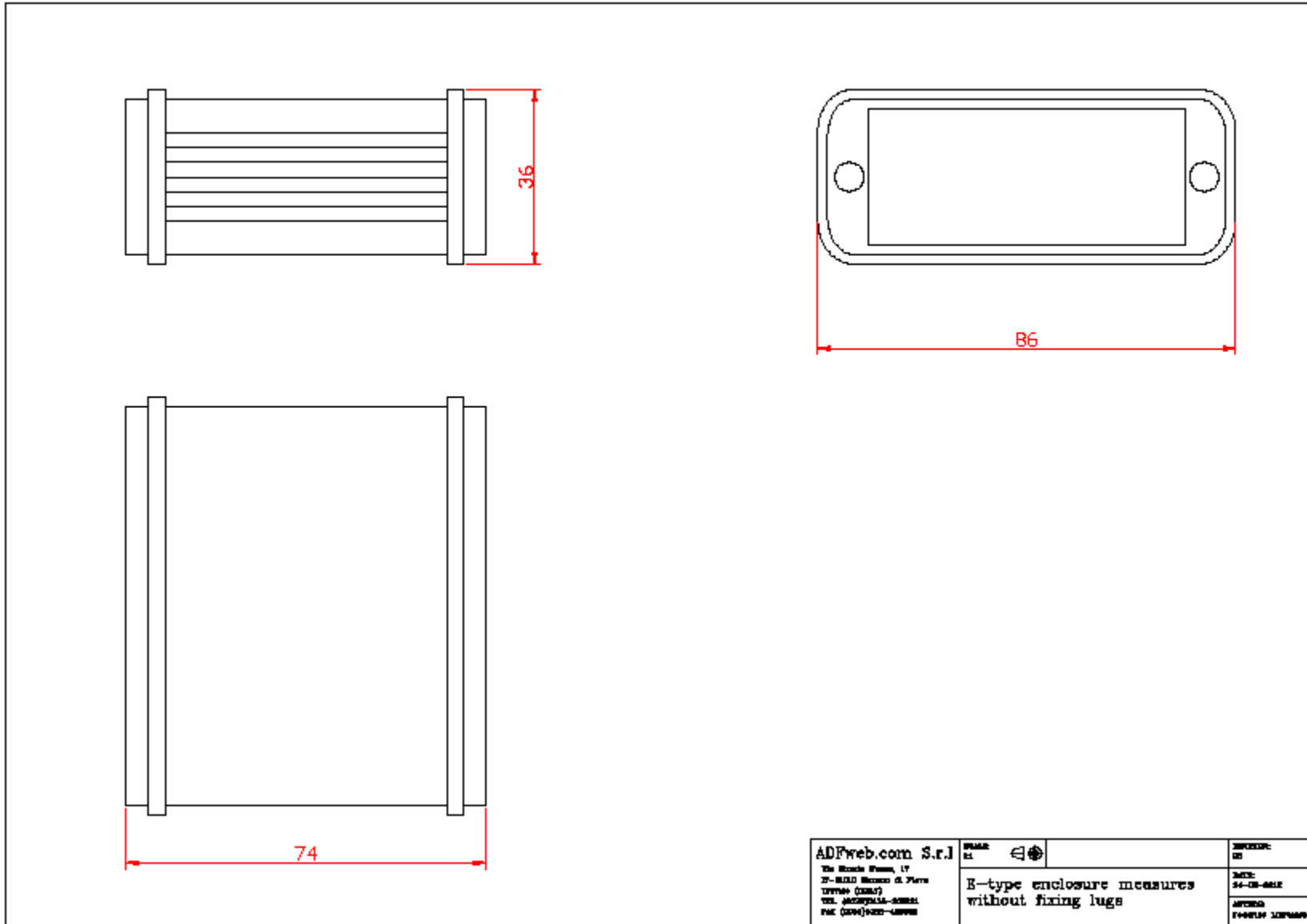
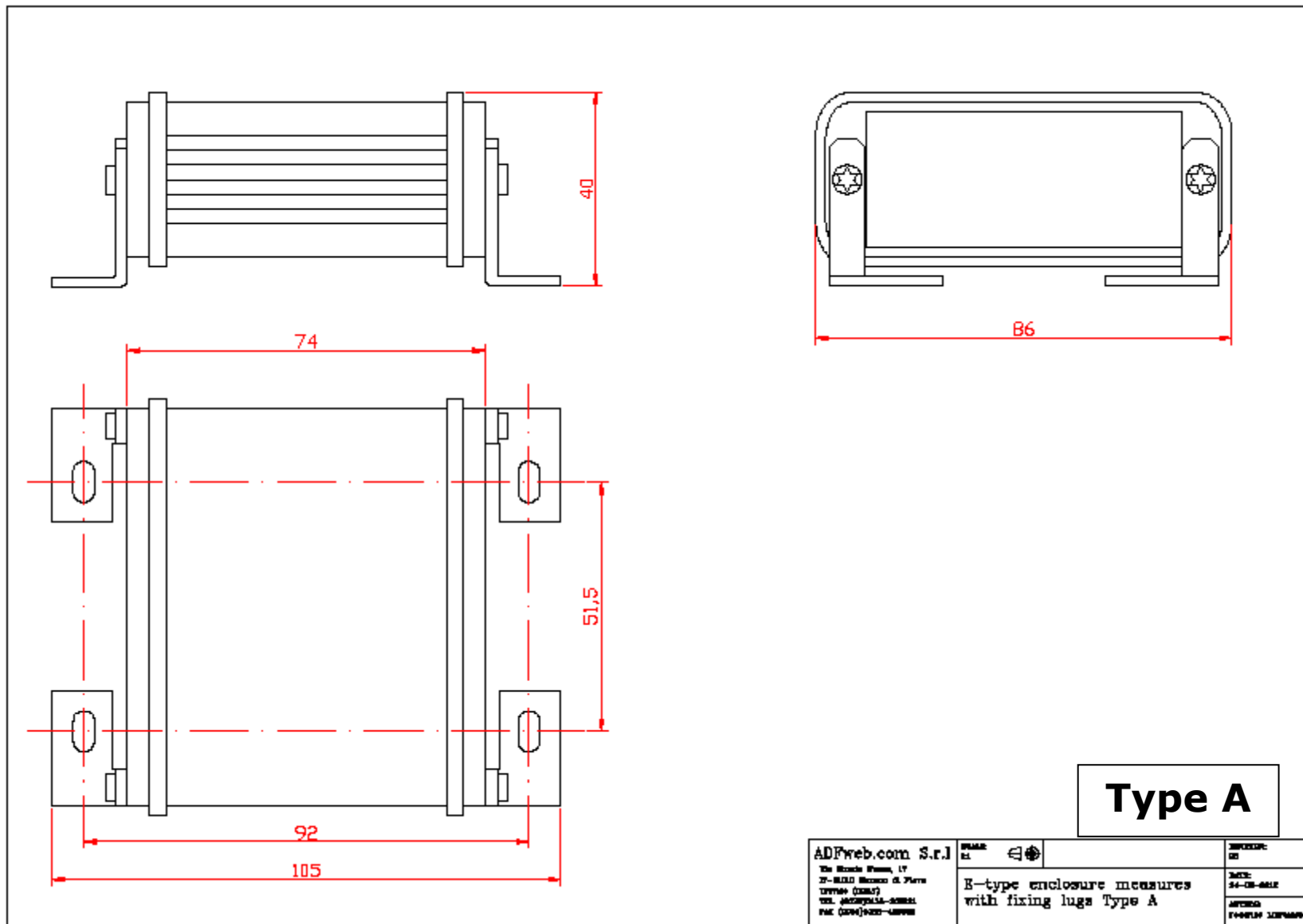

Figure 10: "Protection" window

In the case of HD674-A003 you have to use the software "SW674-A003": www.adfweb.com/download/filefold/SW674-A003.zip.

MECHANICAL DIMENSIONS:





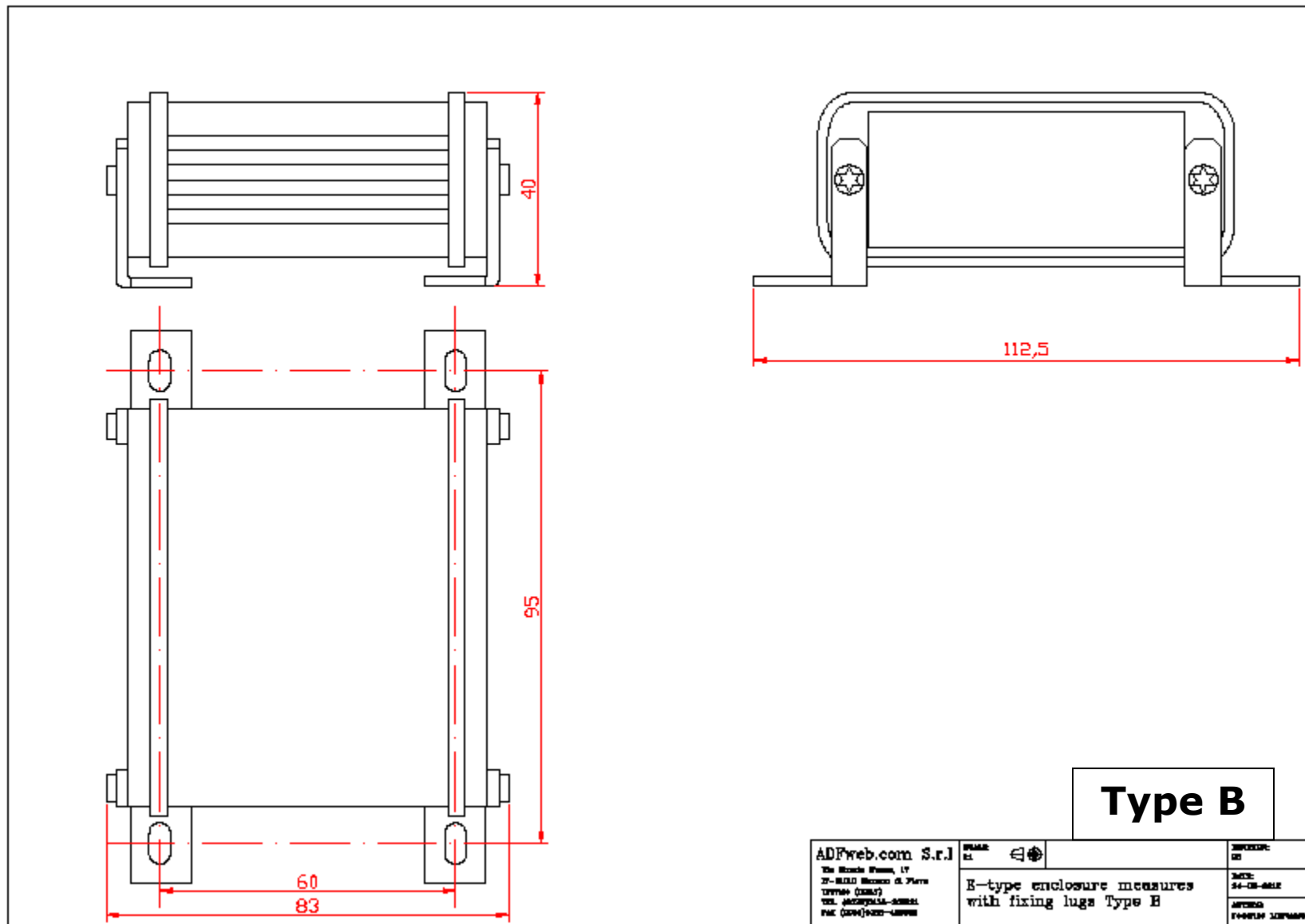

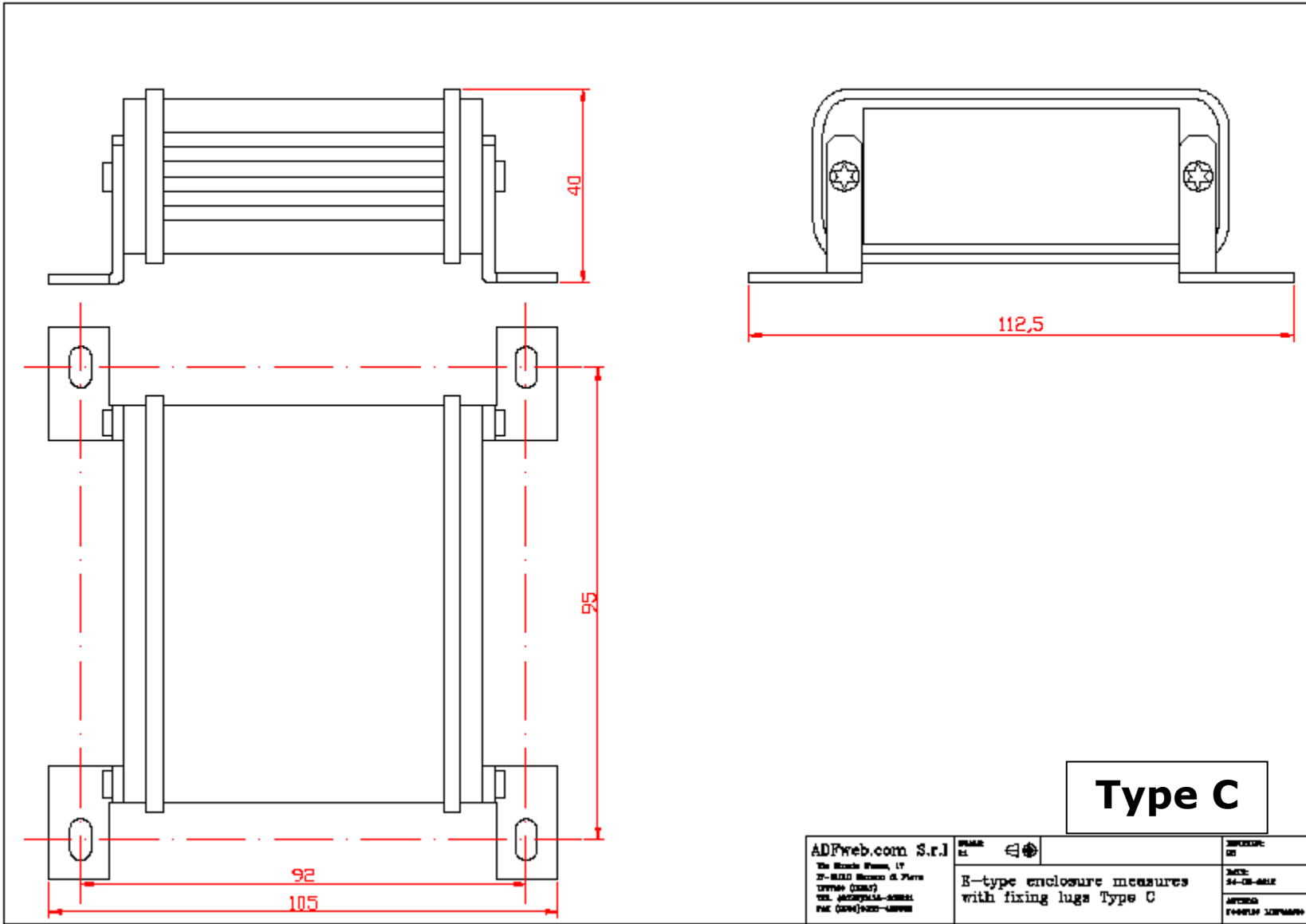

ORDERING INFORMATIONS:

The ordering part number is formed by a valid combination of the following:

HD674-A003 - E y z - s f

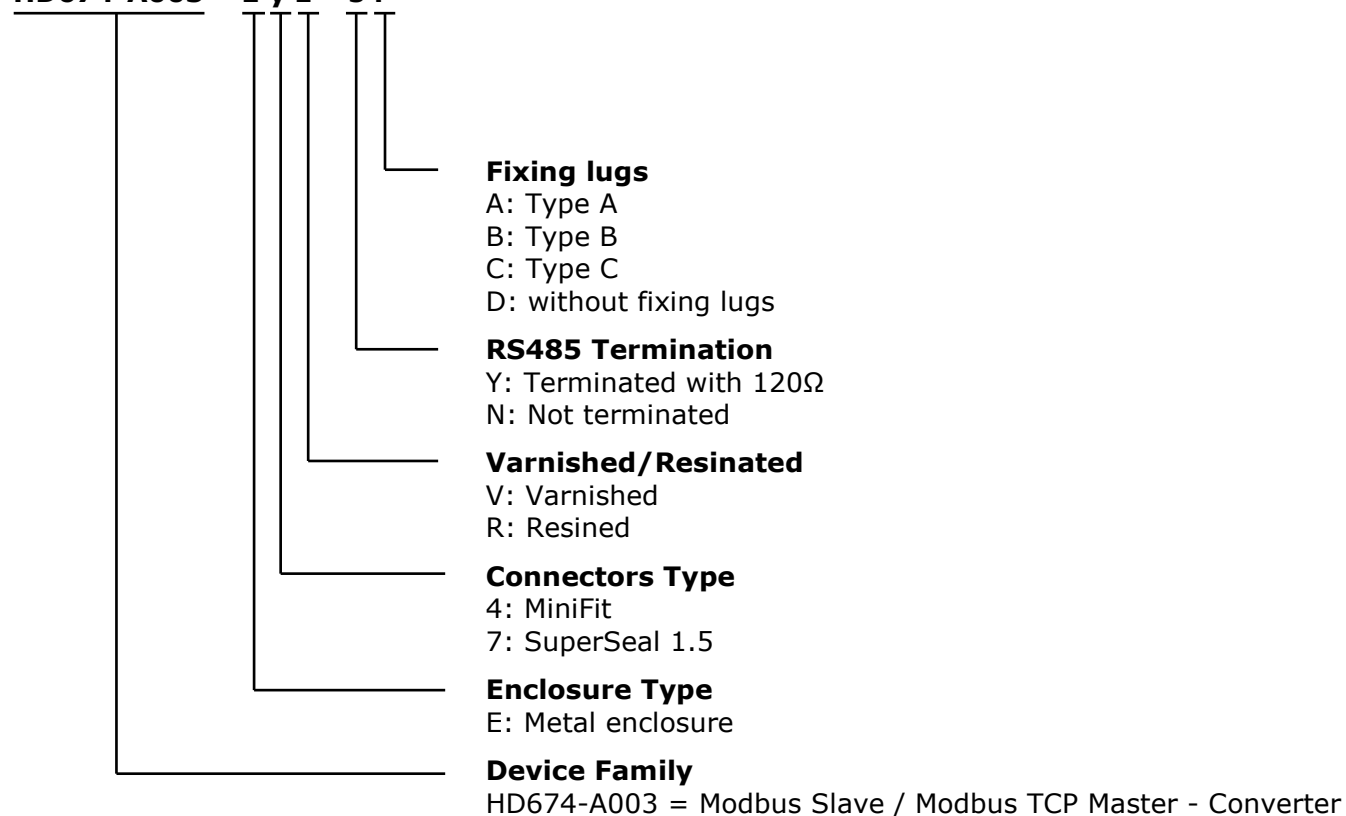

ACCESSORIES:

- Order Code: **AC34011** - Rail DIN - Power Supply 220/240V AC 50/60Hz – 12 V DC
- Order Code: **AC34012** - Rail DIN - Power Supply 220/240V AC 50/60Hz – 24 V DC
- Order Code: **AC67410** - Accessory Automotive Devices - Support for rail DIN

DISCLAIMER:

All technical content within this document can be modified without notice. The content of the document is a under continual renewal. For losses due to fire, earthquake, third party access or other accidents, or intentional or accidental abuse, misuse, or use under abnormal conditions repairs are charged to the user. ADFweb.com S.r.l. will not be liable for accidental loss of use or inability to use this product, such as loss of business income. ADFweb.com S.r.l. shall not be liable for consequences of improper use.

OTHER REGULATIONS AND STANDARDS:**WEEE INFORMATION**

Disposal of old electrical and electronic equipment (as in the European Union and other European countries with separate collection systems).

— This symbol on the product or on its packaging indicates that this product may not be treated as household rubbish. Instead, it should be taken to an applicable collection point for the recycling of electrical and electronic equipment. If the product is disposed correctly, you will help prevent potential negative environmental factors and impact of human health, which could otherwise be caused by inappropriate disposal. The recycling of materials will help to conserve natural resources. For more information about recycling this product, please contact your local city office, your household waste disposal service or the shop where you purchased the product.

RESTRICTION OF HAZARDOUS SUBSTANCES DIRECTIVE

The device respects the 2002/95/EC Directive on the restriction of the use of certain hazardous substances in electrical and electronic equipment (commonly referred to as Restriction of Hazardous Substances Directive or RoHS).

CE MARKING

The product conforms with the essential requirements of the applicable EC directives.

WARRANTIES AND TECHNICAL SUPPORT:

For fast and easy technical support for your ADFweb.com SRL products, consult our internet support at www.adfweb.com. Otherwise contact us at the address support@adfweb.com

RETURN POLICY:

If while using your product you have any problem and you wish to exchange or repair it, please do the following:

- Obtain a Product Return Number (PRN) from our internet support at www.adfweb.com. Together with the request, you need to provide detailed information about the problem.
- Send the product to the address provided with the PRN, having prepaid the shipping costs (shipment costs billed to us will not be accepted).

If the product is within the warranty of twelve months, it will be repaired or exchanged and returned within three weeks. If the product is no longer under warranty, you will receive a repair estimate.



ADFweb.com S.r.l.
Via Strada Nuova, 17
IT-31010 Mareno di Piave
TREVISO (Italy)
Phone +39.0438.30.91.31
Fax +39.0438.49.20.99
www.adfweb.com

